

**OI-6900-X-X-K-2B**  
**Explosion-Proof**  
**Ambient Air**  
**Dual Battery**  
**Toxic Gas**  
**Detector For**  
**Group B Applications**

**OPERATION MANUAL** REV 1.2

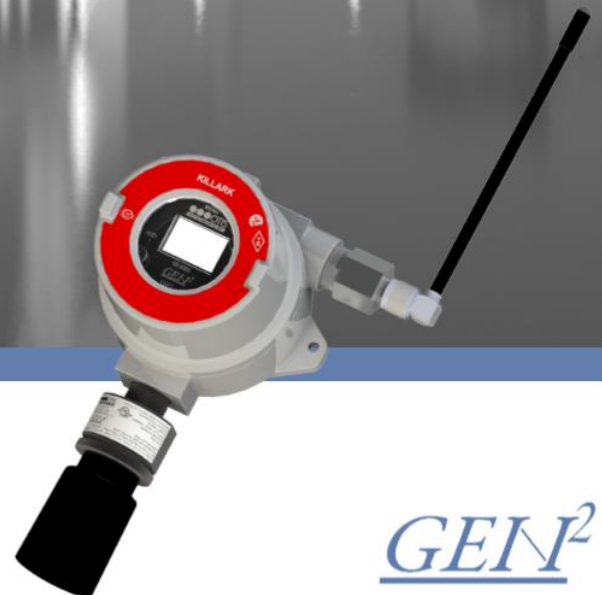

*GEN<sup>2</sup>*



## **CAUTION**

WARNING – EXPLOSION HAZARD – SUBSTITUTION OF COMPONENTS MAY IMPAIR SUITABILITY FOR CLASS I, DIVISION 1, OR EQUIVALENT AS STATED IN USER MANUAL

AVERTISSEMENT – RISQUE D'EXPLOSION-LA SUBSTITUTION DE COMPOSANTS PEUT RENDRE CE MATERIEL INACCEPTABLE POUR LES EMPLACEMENTS DE CLASSE I, DIVISION

CAUTION: FOR SAFETY REASONS, THIS EQUIPMENT MUST BE OPERATED AND SERVICED BY QUALIFIED PERSONNEL ONLY. READ AND UNDERSTAND THE INSTRUCTION MANUAL COMPLETELY BEFORE OPERATING OR SERVICING.

ATTENTION: POUR DES RAISONS DE SECURITE, CET ÉQUIPEMENT DOIT ETRE UTILISE ENTRETENU ET REPARER UNIQUEMENT PAR UN PERSONNEL QUALIFIE. ETUDIER LE MANUEL D' INSTRUCTIONS EN ENTIER AVANT D' UTILISER, D' ENTERETENIR OU DE RÉPARER L' ÉQUIPEMENT.

CAUTION: THIS AREA MUST BE FREE OF FLAMMABLE GASES DURING CALIBRATION.

ATTENTION : CETTE ZONE DOIT ETRE EXEMPTÉ DE GAZ INFLAMMABLES PENDANT L'ETALONNAGE.

CAUTION:TO PREVENT IGNITION OF EXPLOSIVE ATMOSPHERES, REMOVE FROM EXPLOSIVE ATMOSPHERE BEFORE SERVICING

## **DANGER**

DANGER: OTIS INSTRUMENTS INC. OI-6900-X-X-K-2B IS AN AMBIENT AIR TOXIC GAS SENSOR ASSEMBLY AND ONLY MONITORS IN THE IMMEDIATE VICINITY OF THE SENSOR HOUSING. A SITE SURVEY IS REQUIRED IN ORDER TO DETERMINE THE BEST PLACEMENT AND QUANTITY OF SENSOR ASSEMBLIES. IMPROPER INSTALLATION CAN LEAD TO AN UNDETECTABLE GAS LEAK WHICH COULD RESULT IN PERSONAL INJURY OR LOSS OF LIFE.

---



# TABLE OF CONTENTS

<b>1</b>	<b>PRODUCT OVERVIEW.....</b>	<b>1</b>
1.1	INTRODUCTION .....	1
1.2	PRODUCT SPECIFICATIONS .....	2
1.3	SYSTEM DIAGRAMS.....	3
1.3.1	EXTERNAL SYSTEM DIAGRAM .....	3
1.3.2	INTERNAL SYSTEM DIAGRAM.....	4
1.3.3	ASSEMBLY DIAGRAM.....	5
<b>2</b>	<b>INSTALLATION AND START-UP.....</b>	<b>6</b>
2.1	PRODUCT PLACEMENT .....	6
2.2	PRODUCT MOUNTING .....	7
2.3	WIRING CONFIGURATIONS .....	7
2.3.1	OPENING THE ENCLOSURE.....	8
2.3.2	CONNECTING THE BATTERIES.....	8
2.3.3	CLOSING THE ENCLOSURE .....	9
2.4	SYSTEM START-UP .....	9
2.5	NORMAL OPERATING MODE.....	10
<b>3</b>	<b>PRODUCT SETTINGS AND CONFIGURATION .....</b>	<b>11</b>
3.1	RELAY TEST .....	11
3.1.1	PERFORMING THE RELAY TEST .....	12
3.2	NETWORK ID.....	12
3.3	SYSTEM INFORMATION .....	13
3.4	NULL/CALIBRATION TIMER INFORMATION .....	13
3.5	UNIT INFORMATION .....	14
3.6	BACKGROUND SETTING.....	14
3.7	CALIBRATION METHOD .....	15
3.8	DISPLAY SCREEN CONTRAST SETTING .....	16
3.9	RETURN TO FACTORY DEFAULT SETTINGS .....	17
3.10	RESET NULL & CALIBRATION VALUES .....	18
<b>4</b>	<b>OPERATION SETTINGS .....</b>	<b>20</b>
4.1	POWERING THE DEVICE .....	20
4.1.1	POWERING ON .....	20
4.1.2	POWERING OFF.....	20
4.2	SENSOR CALIBRATION.....	21
4.2.1	NULLING THE SENSOR (AUTONULL) .....	21
4.2.2	CALIBRATING THE SENSOR (MANUAL CAL) .....	23
4.2.3	CALIBRATING THE SENSOR (AUTOCAL) .....	24
4.3	SENSOR RADIO ADDRESS .....	26
4.3.1	SENSOR RADIO ADDRESS SETTING .....	26

---

<b>5</b>	<b>PRODUCT MAINTENANCE.....</b>	<b>27</b>
5.1	SCHEDULED MAINTENANCE.....	27
5.2	SENSOR REPLACEMENT.....	28
5.3	BATTERY REPLACEMENT.....	29
5.4	PRODUCT TROUBLESHOOTING.....	31
5.5	PRODUCT REPLACEMENT PARTS AND ACCESORIES.....	32
<b>APPENDIX A: PRODUCT WARRANTY STATEMENT.....</b>		<b>34</b>
<b>APPENDIX B: INFORMATION ABOUT RMA SERVICE REPAIRS.....</b>		<b>36</b>
<b>APPENDIX C: INFORMATION ABOUT RMA RETURNS FOR CREDIT.....</b>		<b>38</b>

# 1 PRODUCT OVERVIEW

## 1.1 INTRODUCTION

The Otis Instruments, Inc. (Otis) GEN II Model OI-6900-X-X-K-2B (OI-6900) Explosion-Proof Ambient Air Toxic Gas Detector is designed to detect a wide range of toxic gases in potentially hazardous environments. This product is component certified for use in Class I, Division 1, Groups B, C and D locations. The OI-6900 features non-intrusive magnetic switches that allow for complete system configuration, regular calibration, and product maintenance to be performed in the field, without opening the enclosure and breaking the seal of the enclosure, thereby compromising the explosion-proof rating of the device. Non-intrusive interface with the OI-6900 is made possible by use of the Otis Magnetic Tool included in the purchase of the device.

The OI-6900 continuously monitors the gas level of the surrounding environment and reports once every minute, the reporting rate will increase to once every five seconds when the detected gas is above the Background Gas set-point. This set-point is adjustable to account for sites that may have a constant low level of gas always present allowing the OI-6900 to maintain a long battery life. When the gas level drops below the set-point the reporting rate will return to once every minute. The OI-6900 display screen will always show the present concentration of gas being detected by the sensor assembly. More information about the Background Gas Set-point is found later in this manual.

This document is an operation manual containing diagrams and step-by-step instructions for the proper and safe installation, start-up, configuration and settings, normal operation, and product maintenance of the OI-6900.

In this manual, the instructions reference the use of push-buttons, located on the front panel of the device. In certain environments, the activation of the non-intrusive magnetic switches, through the use of the Otis Magnetic Tool, will replace the directive of the button-press actions. To apply the Otis Magnetic Tool, hold the tool to the side of the device enclosure adjacent to the push-button that you wish to activate. When the magnetic switch is toggled, an on-screen indicator will appear on the display screen, signifying that a connection was made.



### NOTICE



This document should be read in its entirety before the initial operation of the product.

Should a question arise during the use of the product, this document will serve as a first reference for the end-user. For inquiries beyond the information and instructions provided within this manual, contact the sales representative of this product for assistance.

## 1.2 PRODUCT SPECIFICATIONS

System Specifications	
Operating Voltage	3.6 VDC 19Ah each, 38 Ah total Lithium-Thionyl (Li-SOCl <sub>2</sub> ) Battery
Estimated Battery Life	Electrochemical - 2 Years Maximum Photo Ionization Detector – 14 Days+
Operating Temperature Range	-20°C to +60°C
Humidity Range	0% to 98% Relative Humidity, Noncondensing
Measurement Range	Varies based on gas type
Response Time	Varies based on gas type
WireFree Radio Option	GEN II 900 MHz – 52 Networks, 255 Sensors per Network GEN II 2.4 GHz – 78 Networks, 255 Sensors per Network
RF Connection	N-Female Radio Frequency (RF) Connector
Display	Transflective (sunlight-readable) 102x64 LCD Screen LED Back-Light
Interface	3 Push-Buttons (MENU, ADD, SUB) 3 Magnetic Switches for Non-Intrusive Calibration

Mechanical Specifications	
Enclosure Materials	Aluminum Device Enclosure
Sensor Housing Materials	303 Stainless Steel Sensor Housing
Product Dimensions	5.30" L x 8.26" W x 17.76" H (Maximum w/ Attachments)
Product Weight	6 lbs. (Maximum w/ Attachments)

Safety Approvals – Main Enclosure	
Enclosure Ratings	Explosion/Flame-Proof
Hazardous Location Certification	Class I, Div. 1 & 2, Groups A, B, C, D Class I, Zones 1 & 2, Groups IIB + H2, IIA Class II, Div. 1 & 2 Groups E, F, G Class III, Type 3, 4, 4X NEMA 3, 4, 4X, 7 (B, C, D) 9 (E, F, G) T <sub>a</sub> -20°C to +60°C
  	

Safety Approvals – Sensor Housing	
Enclosure Ratings	Explosion/Flame-Proof
Hazardous Location Certification	Class I, Division 1, Groups B, C and D T <sub>Amb</sub> -40°C to +60°C
	



### 1.3 SYSTEM DIAGRAMS

Refer to the following diagrams for identification of the external and internal system components that may be referred to in this manual.

#### 1.3.1 EXTERNAL SYSTEM DIAGRAM

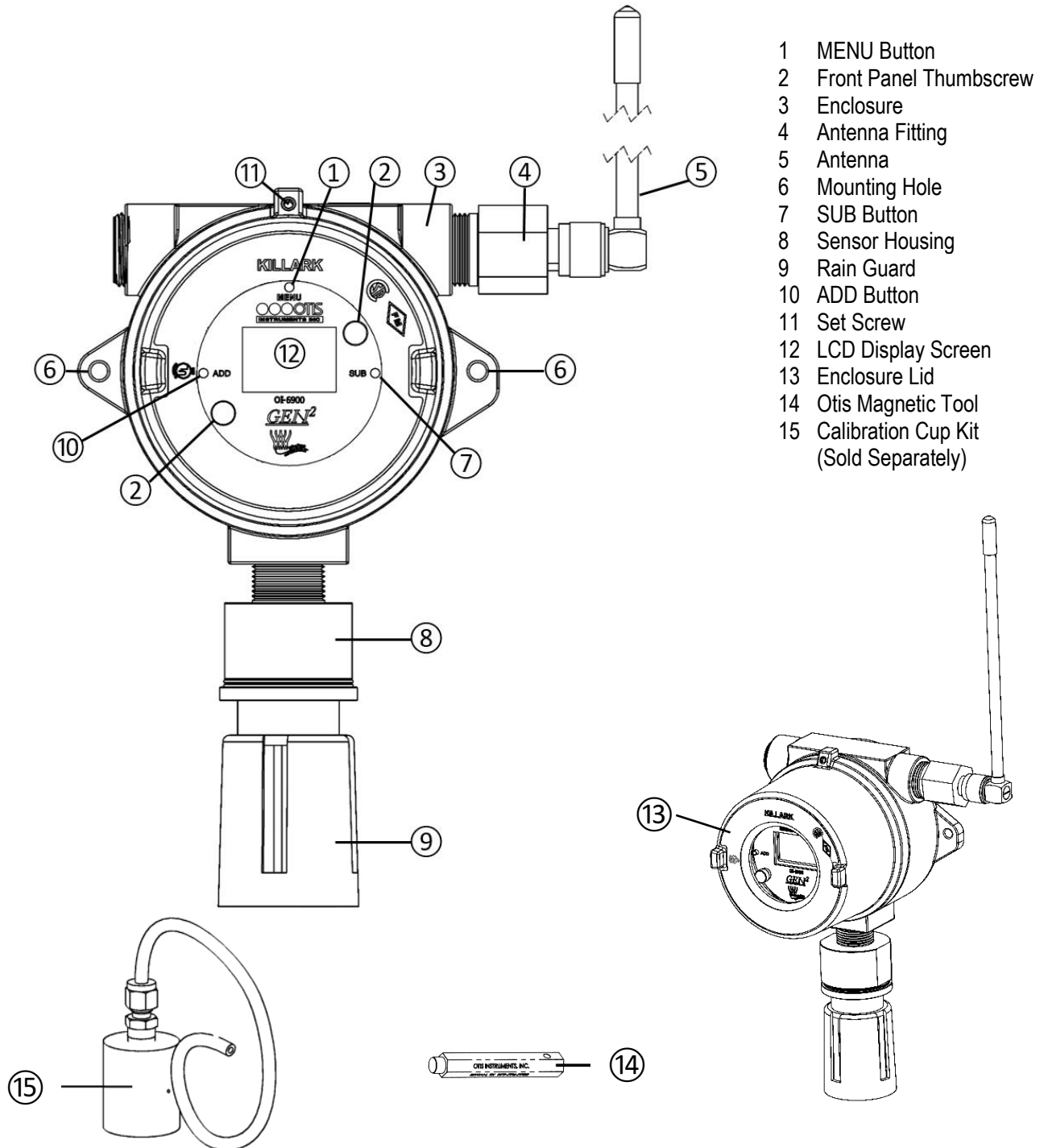

### 1.3.2 INTERNAL SYSTEM DIAGRAM

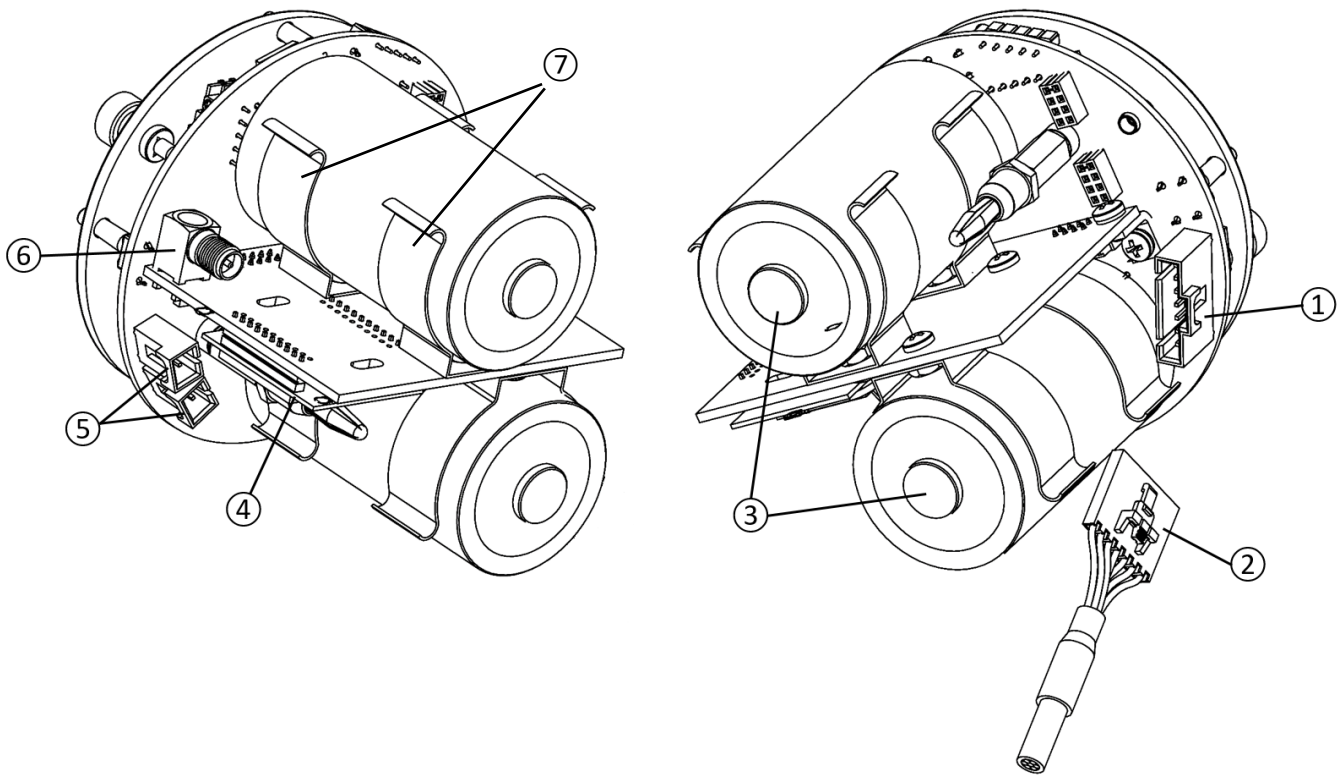

- 1 Sensor Housing Connector
- 2 Sensor Housing Plug
- 3 Batteries
- 4 Radio Module
- 5 Battery Connectors
- 6 Antenna Fitting Connector
- 7 Battery Spring Clips

### 1.3.3 ASSEMBLY DIAGRAM

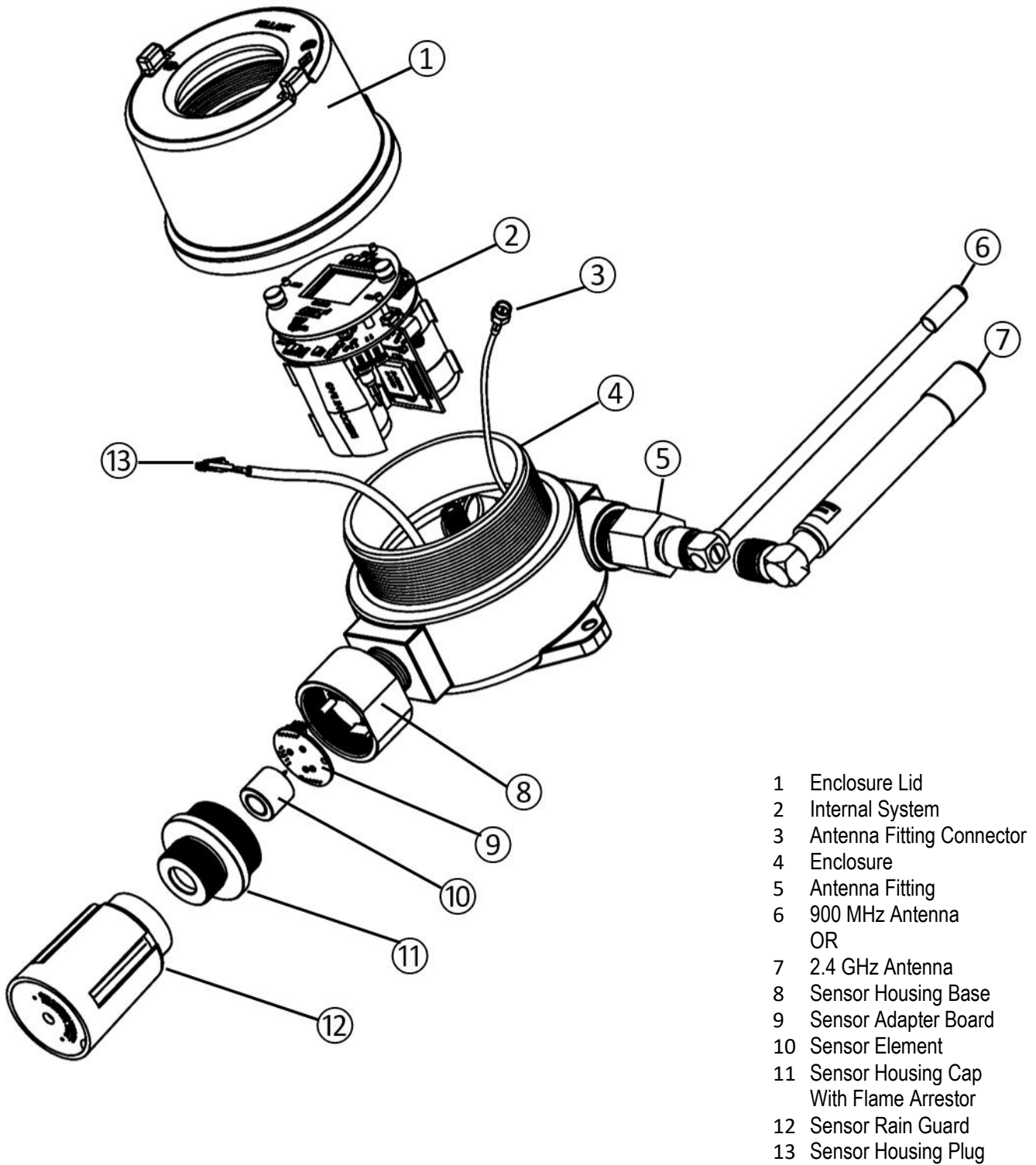

## 2 INSTALLATION AND START-UP

### 2.1 PRODUCT PLACEMENT

The installation instructions, and any other information supplied by Otis, provide only basic guidelines relating to the properties of combustible gas and the effects of environmental conditions on the OI-6900 device. Sensor placement should be determined in consultation with the site safety personnel, as well as those knowledgeable of: (1) the site/facility where the equipment is being installed and (2) the potentially present gas types and their dispersion. Otis strongly recommends that the end-user consults with the appropriate third party Health, Safety and Environmental (HSE) and Industrial Hygiene (IH) professionals to determine the final quantity and placement of your gas detection devices.

The primary purpose of the OI-6900 is to provide an early warning of the accumulation of toxic gas, in order to minimize hazards to people and property. Proper placement of the device is paramount to achieving this goal.

The following general guidelines should be considered when determining the placement of the OI-6900:

- The unit should be placed greater than 6.5 Feet/2 Meters away from a monitor in order to ensure reliable communications
- The unit shall be placed such that the position of the sensor housing is pointing downward to the ground.
- Avoid installing the unit in a location where airborne particles could cover or coat the sensor head.
- The unit should be placed in an area that will produce the highest gas concentration. Enclosed corners and stopping points of moving devices are two areas susceptible to a buildup of combustible gas.
- In order to provide an accurate representative sample of a room, care should be taken to avoid locating the unit near a room entrance, fresh air intake vent, or vehicle/generator exhaust point.
- The unit should be placed as close as physically possible to the source of the potential toxic gas leak.
- In consideration of possible ignition points, the unit should be placed between the potential leak source and ignition point.
- Consider placing the unit in a seldom used area, such as a warehouse, storage area, or other unfrequented location.
- Consider accessibility for regular calibration and other required maintenance.
- When monitoring a ventilated gas cylinder storage area, the unit should be placed near the air return vent.
- When monitoring an outdoor or open-air area, the unit should be placed near the air intake of the HVAC system of the building.
- When monitoring for the potential presence of multiple toxic gas types, the unit should be calibrated for the least cross-sensitive toxic gas.



#### NOTICE

These guidelines are **ONLY** intended as a general directive for the placement of the OI-6900. This information should **NOT** serve as a complete list when considering all potential parameters for the proper location of the unit. It is **STRONGLY** advised that a third party Certified Industrial Hygienist, or other Certified Safety Professional, conduct a site survey and annotate the location and quantity of detection devices that should be installed for **EVERY** installation of **EVERY** site.

## 2.2 PRODUCT MOUNTING

It is recommended to mount the unit to a solid structure (such as a concrete wall, steel column, or angle iron) where a minimum of vibration will be transmitted to the unit. Alternately, a pole may be used along with a strap or a U-bolt, as long as it is rigid and of sufficient strength. Wooden structures are not recommended for mounting, as they trap moisture (which could affect sensor performance) and their mounting rigidity degrades over time (screws/bolts weaken and fall out or corrode).

Any style of bolt or screw may be used as long as it is steel and meets or exceeds the following:

- Maximum ¼"-20 bolt or Ø¼" screw (length varies with user need)
- Flat washers for bolts/nuts/screws
- Minimum Grade 5 (or better)
- Corrosion protection for all hardware (paint, galvanize, zinc plating, etc.)

## 2.3 WIRING CONFIGURATIONS

The OI-6900 is powered by dual 3.6V/19AH Lithium-Thionyl batteries. The batteries should be replaced in pairs and you should not mix old and new batteries.



### CAUTION

- ◆ The internal components can be static sensitive. Use caution when opening the enclosure and handling internal components.
- ◆ **DO NOT** use any metal objects or tools to remove the terminal board from the internal system.
- ◆ **DO NOT** mix old and new batteries.



### WARNING

- ◆ When securing the lid onto the device, tighten the enclosure lid by hand **ONLY**. Overtightening of the lid by use of hand-tools could result in damage to the O-ring, potentially compromising the moisture seal, resulting in an unsafe environment.
- ◆ Use **ONLY** Otis supplied batteries in this device.

### 2.3.1 OPENING THE ENCLOSURE

To prepare the OI-6900 for installation, you must first open the device, exposing the control board and its components to connect the batteries.

1. Remove the enclosure lid, unscrewing it from the device enclosure. Set aside.
2. Gripping the front panel thumbscrews, lift the internal system out of the enclosure and rest it against the rim of the enclosure opening.



#### NOTICE

Disconnecting the sensor connector plug from the sensor housing connector and the antenna fitting cable will allow for the complete removal of the internal system from the device enclosure. Disconnecting the internal system may provide ease in accessing the control board terminals for connecting the battery plug into the battery connectors. If this step is performed, it is essential that all connections are rejoined before returning the internal system back into the enclosure.

### 2.3.2 CONNECTING THE BATTERIES

To provide power to the OI-6900 you will need to connect the battery connectors to the OI-6900 battery terminals located on the control board. Refer to the following instructions for how to connect the batteries to your device:

On the GEN II Model OI-6900 Detector:

1. Plug the battery on the bottom of the radio board into the closer 2-pin battery terminal.
2. Plug the battery on the top of the radio board into the other available 2-pin battery terminal.

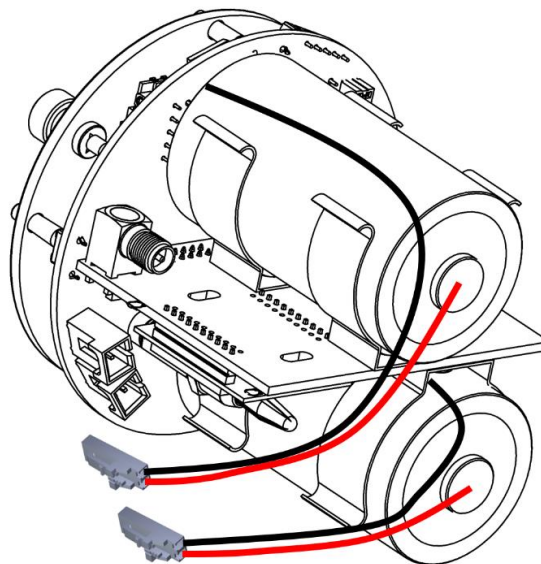

### 2.3.3 CLOSING THE ENCLOSURE

1. Place the internal system back into the device enclosure, matching each mounting post to its corresponding eyelet anchored within the base of the enclosure.
2. Using the thumbscrews, gently push to seat the internal system into the mounting posts.



#### NOTICE

The thumbscrews on the OI-6900 function **ONLY** as thumb-holds for ease in removal of the internal system from the base of the enclosure. Do **NOT** attempt to loosen or tighten the thumbscrews when opening or closing the enclosure.

3. Verify that the sealing ring, seated at the threaded opening of the device enclosure, is correctly in place.
4. Affix the enclosure lid back onto the device, rotating the lid until it is tightly screwed into place.

### 2.4 SYSTEM START-UP

After power is applied, the unit will enter into OFF mode. Once the enclosure is properly closed you may turn the unit ON and begin its 1-minute warmup period. During warmup, the display will show a countdown of the time remaining until the system start-up is complete. The Otis logo and the unit information will also flash on the display screen during start-up.

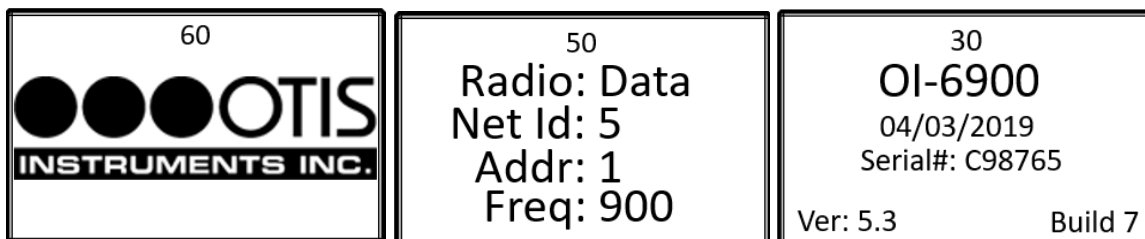

At the end of the countdown, the device will be in normal operating mode.

## 2.5 NORMAL OPERATING MODE

During normal operating mode, the OI-6900 continuously samples the air and updates the measured concentration of the target gas on the display screen. The display, when in normal operation, appears as shown below.

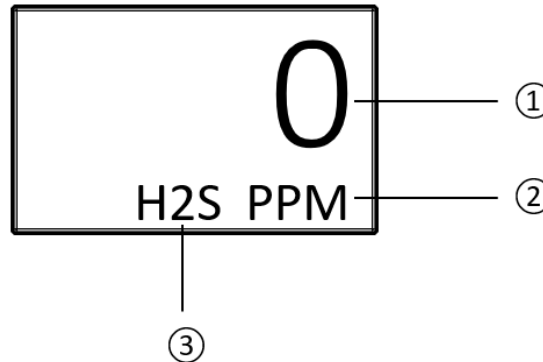

- 1 Measured gas concentration (reading)
- 2 Gas concentration unit of measure
- 3 Sensor element gas type

In the event of a device failure, the unit will alternate between the normal operating screen and a fault screen on the display, in 5 second intervals, until the fault has been cleared, or is corrected. The fault code, located in the bottom-left corner of the display, appears on both screens. The unit continuously registers that the system is in fault, so that even with at-a-glance instrument checks in the field, it can be seen. When the system is restored, the unit will return to normal operating mode.

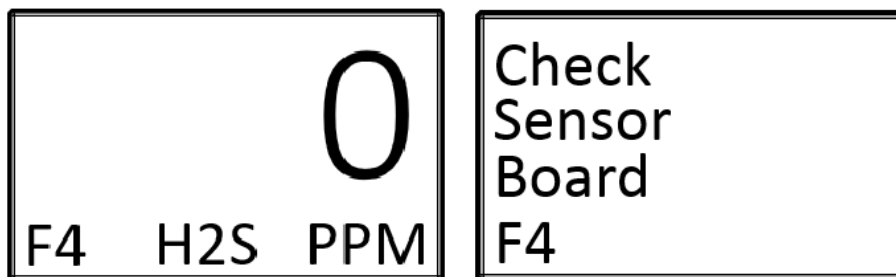

For a list of the fault codes and warning symbols of the OI-6900, and their associated meaning, refer to the Product Troubleshooting section of this manual.

Both system menus are accessible from the normal operating mode. To access the product settings and configuration menu, **press and hold** the **MENU** button, for approximately 6 seconds, until the menu is activated and open on the display screen. To access the operation settings menu from the normal operating screen, press the **MENU** button once and the menu will open and show on the display.



### NOTICE

After 5 minutes of no interaction with the device, the unit will automatically return to normal operating mode.



## 3 PRODUCT SETTINGS AND CONFIGURATION

The product settings and configuration menu allows the end-user to tailor the device settings to meet their required specifications and/or site conditions.

The product settings and configuration menu consist of the following screens:

- Relay Test
- Network ID
- System Information
- Null/Calibration Timers
- Unit Info
- Background Setting
- Calibration Method
- Display Screen Contrast Setting
- Return to Factory Default Settings
- Reset Null & Calibration Values

While the device is in normal operating mode, **press and hold** the **MENU** button, for approximately 6 seconds, until the product settings and configuration menu is activated and open on the display screen.

### 3.1 RELAY TEST

The relay test simulates a gas level reading, indicating the presence of a toxic gas at the sensor. The relay test is used to ensure the proper functionality of the relay settings on the monitor. The test can also be used to simulate emergency/safety drills onsite.



#### NOTICE

The triggering of relays from the detector will also simulate low and high level alarm relays at the monitor. Monitors cannot distinguish between real and simulated data received. When the monitor relays are triggered, alarming devices will perform as intended, initiating emergency procedures as if a harmful or toxic gas was actually present. To prevent this from occurring, set the monitor to calibration mode before performing the relay test. Calibration mode of the monitor will allow the transmission of the data, without the activation of the monitor relays. Consult the Sensor Calibration section of this manual for instructions on how to perform this procedure.

It is recommended that a relay test be conducted **EVERY** 30 days, alongside the maintenance and calibration of the detector.

### 3.1.1 PERFORMING THE RELAY TEST

The relay test gas level reading can be increased or decreased in increments of 5% of the sensor scale, up to 100% of the sensor scale.



1. Press the **ADD** button until the low and high alarm levels are reached and the relay(s) are triggered to light all visual alarm(s) and sound all audio alarm(s) on the monitor.
2. Once all relays have been tested and the test is complete, press the **SUB** button to return the relay test reading back to zero and to deactivate the monitor alarm(s).
3. Press the **MENU** button to advance to the Network ID screen.

### 3.2 NETWORK ID

The Network ID is used to synchronize the communication between the Otis Monitor and Sensor Assembly:

- There are 52 networks available with the GEN II 900 MHz radio.
- There are 78 networks available with the GEN II 2.4 GHz radio.
- The monitor and sensor assembly must have the same Network ID in order to communicate.

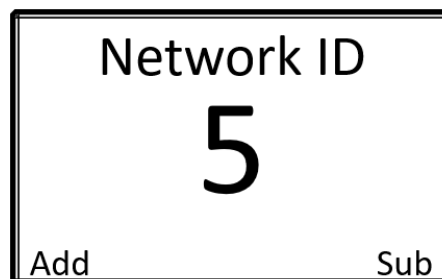

1. Press the **ADD** or **SUB** button until the Network ID matches the value being used on the Primary Monitor.
2. Press the **MENU** button to advance to the System Information screen.

### 3.3 SYSTEM INFORMATION

The system information screen allows the end-user to view the following information:

- The connection status to the Primary Otis Monitor.
- The scale of the sensor element.
- The battery voltage of the device.
- The voltage value the sensor was reading when nulled in Volts.
- The current voltage value the sensor element is reading in Volts.

This screen is for informational purposes only.

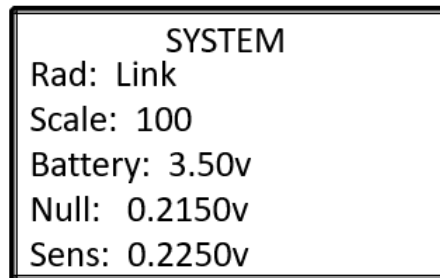

1. Press the **MENU** button to advance to the Null/Calibration Time Information screen.

### 3.4 NULL/CALIBRATION TIMER INFORMATION

The null/calibration time information screen allows the end-user to view the following information:

- The days since the sensor assembly was last nulled, only updates while the unit is turned on.
- The days since the sensor assembly was last calibrated, only updates while the unit is turned on.
- The calibration number of the sensor, used for diagnostic purposes.

This screen is for informational purposes only.

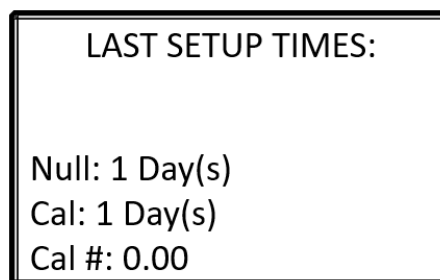

1. Press the **MENU** button to advance to the Unit Information screen.

### 3.5 UNIT INFORMATION

The unit information screen allows the end-user to view the following information:

- The number of times the radio has transmitted and not received an acknowledgement.
- The date of manufacture of the sensor assembly.
- The serial number of the sensor assembly.

This screen is for informational purposes only.

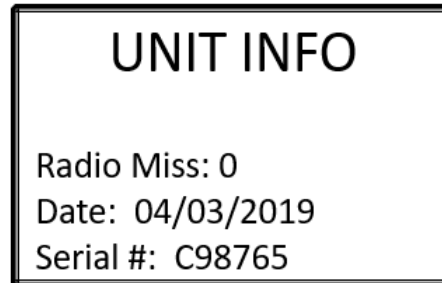

1. Press the **MENU** button to advance to the Background Setting screen.

### 3.6 BACKGROUND SETTING

The background setting is the gas reading at which the radio transmission changes from once every minute to once every five seconds. The background setting is adjustable so that if there is a consistent level of gas always present the sensor will not increase the radio transmission rate, this leads to longer battery life on sites where a consistent low level of gas is always present in the background.

- The default background level is 4% of the sensor element scale.
- The minimum that the background can be set to is 1% of the sensor element scale.
- The maximum that the background can be set to is 100% of the sensor element scale.

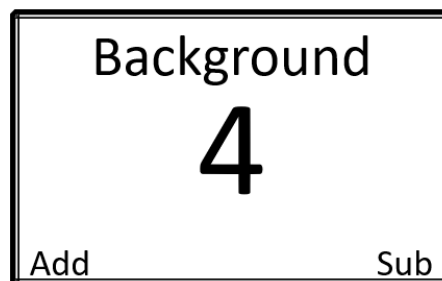

1. Press the **ADD** or **SUB** button until the Background is set to the desired level.
2. Press the **MENU** button to advance to the Calibration Method screen.

## 3.7 CALIBRATION METHOD

The calibration method selection allows you to choose how you calibrate the sensor element. Manual calibration is the default method for all gas types, except CO<sub>2</sub> where Auto calibration is the only option and this screen will not appear.

- Manual calibration lets you use the **ADD** and **SUB** buttons during calibration to match the reading shown on the screen to the value of the gas being applied.
- Auto calibration will set the reading, after a predetermined amount of time, during calibration to the value entered during the auto calibration setup process.

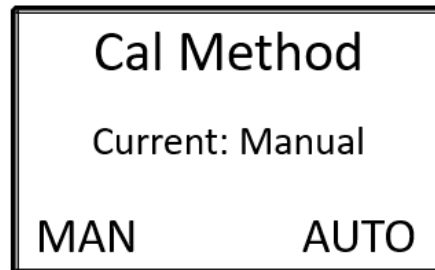

1. Use the **ADD** button to select manual calibration and the **SUB** button to select auto calibration.
2. Press the **MENU** button to advance to the display screen contrast setting screen.

## 3.8 DISPLAY SCREEN CONTRAST SETTING

The display screen contrast is the difference in luminance or color that makes the displayed images distinguishable. Due to varying external elements, such as extreme sunlight, the brightness of the display screen may need to be adjusted for optimum viewing.

The factory default setting on the OI-6900 for the display screen contrast is 53, approximately 83% of the contrast scale. The contrast setting ranges from 1 to 64.



### NOTICE

Setting the contrast too low will cause the display image to become faint or indistinguishable, especially when the unit is located in areas with full-sun. The resulting field of view could be misinterpreted as an error within the device. Be sure to verify that the selected contract is within an appropriate range of viewing.

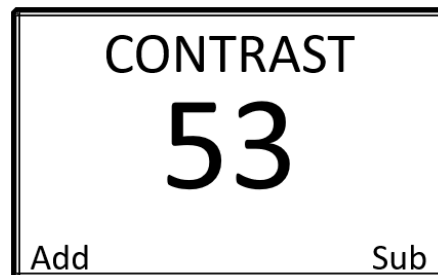

3. Use the **ADD** and **SUB** buttons to brighten and dim the contrast, respectively.
4. Press the **MENU** button to select the desired setting and to advance to the return to factory default settings screen.

### 3.9 RETURN TO FACTORY DEFAULT SETTINGS

Returning the OI-6900 to its factory default settings will reset all customization of the device, including the null and calibration settings of the sensor element.

#### OI-6900 Product and Configuration Factory Default Settings

Configuration	Setting
Relay Test	--
Network ID	5
System Information	--
Null/Calibration Timer	*Cleared*
Unit Information	--
Calibration Method	Manual
Background Setting	4
Contrast	--

#### OI-6900 Operation Factory Default Settings

Configuration	Setting
Sensor Element Null	*Cleared*
Sensor Element Calibration	*Cleared*
Sensor Radio Address	1

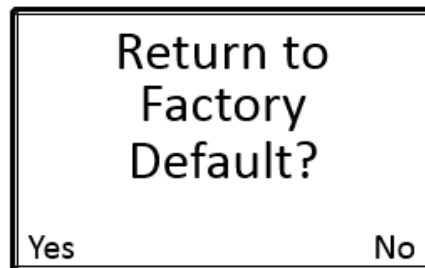

1. Press the **ADD** button to select "Yes" to return the device to its factory default settings and to advance to the return to factory default settings confirmation screen. If you do not wish to return the device to its factory default settings, press the **SUB** button to select "No" to leave the product settings and configuration menu and to return the device to normal operating mode.

If “Yes” is selected to return the device to its factory default settings:

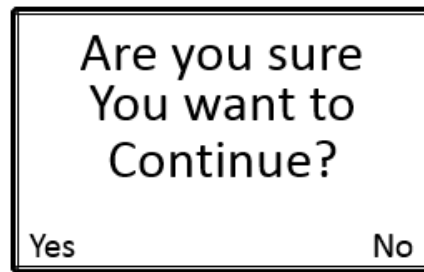

1. Press the **ADD** button to select “Yes” to confirm that you want to reset the device to its factory default settings and to return the device to normal operating mode. If you do not wish to continue to return the device to its factory default settings, press the **SUB** button to select “No” to leave the product settings and configuration menu and to return the device to normal operating mode.



## NOTICE

If the OI-6900 is reset to the factory default settings, the configuration steps **MUST** be repeated and the device **MUST** then be nulled and calibrated for proper operation of the device.

### 3.10 RESET NULL & CALIBRATION VALUES

Resetting the null and calibration settings of the sensor element will allow the currently stored null and calibration values to be reset without having to reconfigure all of the other operational settings like with the Return to Factory Defaults option.

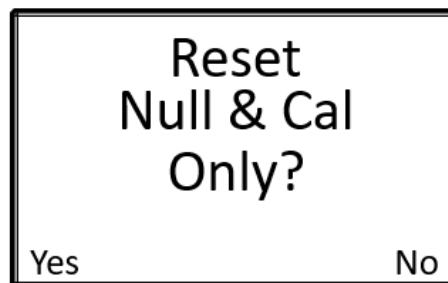

1. Press the **ADD** button to select “Yes” to reset the Null and Calibration values and to advance to the Reset Null & Cal Only confirmation screen. If you do not wish to reset the null and calibration values, press the **SUB** button to select “No” to leave the product settings and configuration menu and to return the device to normal operating mode.



If “Yes” is selected to return the device to its factory default settings:

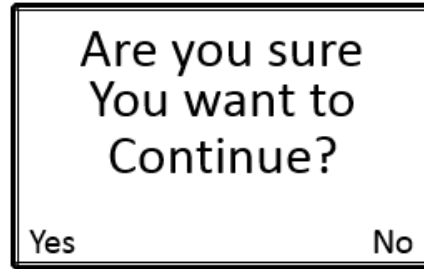

2. Press the **ADD** button to select “Yes” to confirm that you want to reset the Null and Calibration values and to return the device to normal operating mode. If you do not wish to continue to return the device to its factory default settings, press the **SUB** button to select “No” to leave the product settings and configuration menu and to return the device to normal operating mode.



## NOTICE

If the OI-6900 stored Null and Calibration values are reset, the device **MUST** be nulled and calibrated for proper and safe operation of the device.

## 4 OPERATION SETTINGS

At the time of installation, when the batteries are first connected to the OI-6900, the unit is automatically placed into OFF mode, pressing the ADD button begins the startup sequence. During the 1-minute warmup, the display will show a countdown of the time remaining until the system start-up is complete. The Otis logo and the unit information will also flash on the display screen and, at the end of the countdown, the device will be in normal operating mode.

### 4.1 POWERING THE DEVICE

#### 4.1.1 POWERING ON

Powering on the device begins the operation of the unit, automatically initiating the system start-up cycle and 1-minute warmup period. The OI-6900 will be in normal operating mode at the completion of the system start-up.

1. Press the **ADD** button once to power the unit.

#### 4.1.2 POWERING OFF

Powering off the device stops the operation of the unit. The product settings and configuration, as well as the operation settings, including the null and calibration of the sensor, will be unaffected.

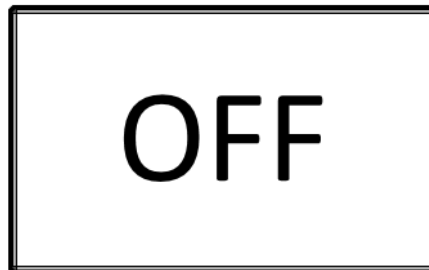

1. **Press and hold** the **SUB** button for approximately 6 seconds, until “OFF” shows on the display screen.

The display screen will continue to show “OFF” for the duration of time that the unit is powered off, as long as the batteries remain plugged into the unit.

## 4.2 SENSOR CALIBRATION

Calibration is the process of evaluating and adjusting the precision and accuracy of measurement equipment. Although Otis calibrates every device at the factory, for best accuracy, the detector **SHOULD** be calibrated in the environment where it is installed.

It is imperative that the calibration occur as part of the installation process, and then **EVERY** thirty (30) days thereafter. Days since last calibration should **NEVER** exceed ninety (90) days. Otis recommends that you calibrate your device regularly to ensure proper functionality and a safe work environment.

### 4.2.1 NULLING THE SENSOR (AUTONULL)

The first step of calibration is nulling the sensor, sometimes referred to as “setting the zero” or “zeroing the sensor.” The nulling process **MUST** be performed in known clean air, with no contaminants or hazardous gasses present. If air quality cannot be guaranteed, a bottle of zero air will be required to properly null the sensor.



1. While the product is in normal operating mode, press the **MENU** button to activate the operation settings menu.

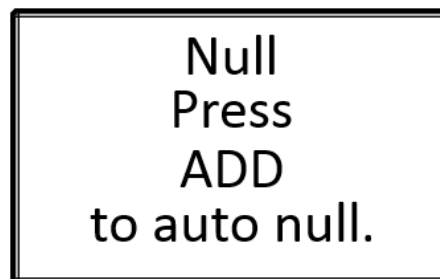

2. Press the **ADD** button to begin the null process and advance to the clean air confirmation screen.

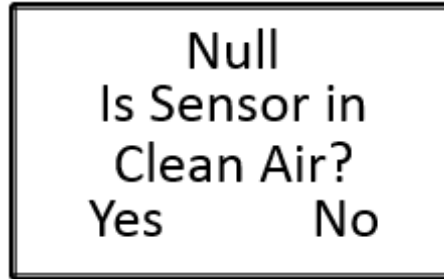

3. Press the **ADD** button to select “Yes” to confirm that the sensor is in clean air and to begin nulling the sensor. If the sensor is not in clean air, press the **SUB** button to select “No” to discontinue the null process and to return to the previous screen.



## NOTICE

If “**Yes**” is selected at this point, the null process cannot be stopped without disconnecting the power from the unit.

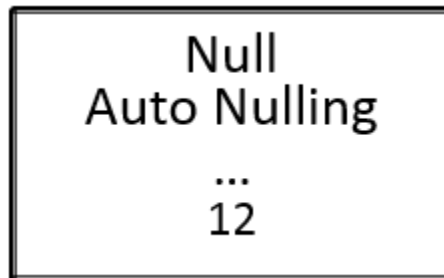

4. The unit will automatically begin the 12-second null process. During null, the display will show a countdown of the time remaining until the process is complete.

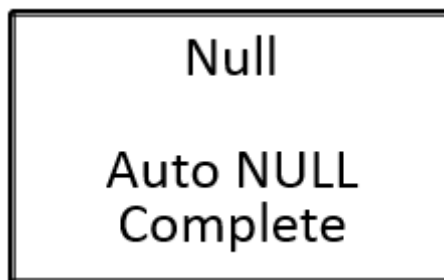

5. When null process is complete, press the **MENU** button to advance to the calibration screen.

## 4.2.2 CALIBRATING THE SENSOR (MANUAL CAL)

You should **ONLY** perform the calibration of the sensor after the null process has been completed. For best results, use 50% of the sensor scale of your target gas in an air balance with a flow rate of 0.25 to 0.5 LPM. The screen below will appear upon entering calibration mode. If Auto Cal was chosen during the **Product Settings and Configuration** section please skip to section 4.2.3.

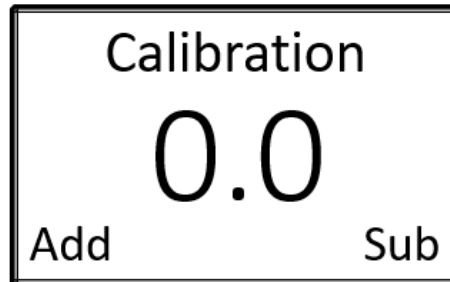

1. Unscrew and remove the rain-guard from the sensor housing, making sure to not unscrew the sensor housing cap.
2. Affix a Calibration Cup Kit (sold separately) to the sensor housing of the device.
3. Affix a regulator to the calibration gas bottle.
4. Attach the tubing on the Calibration Cup Kit to the regulator on the calibration gas bottle.
5. Ensure that the gas is flowing and watch the reading increase. When the reading stabilizes, approximately 1 ½ to 2 minutes, use the **ADD** and **SUB** buttons to adjust the reading on the screen to match the applied calibration gas concentration.

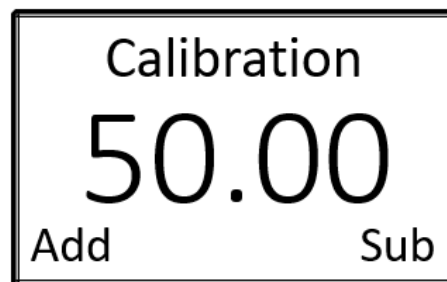

### NOTICE

If the sensor responds extremely slow, or does not respond to the applied gas, it may indicate a failed sensor element. The sensor element will need to be replaced before completing the null and calibration process.

6. When calibration is complete, detach the Calibration Cup Kit from the sensor housing and reattach the rain guard. Press the **MENU** button to advance to the sensor Radio Address screen.

### 4.2.3 CALIBRATING THE SENSOR (AUTOCAL)

You should **ONLY** perform the calibration of the sensor after the null process has been completed. For best results, use 50% of the sensor scale of your target gas in an air balance with a flow rate of 0.25 to 0.5 LPM.

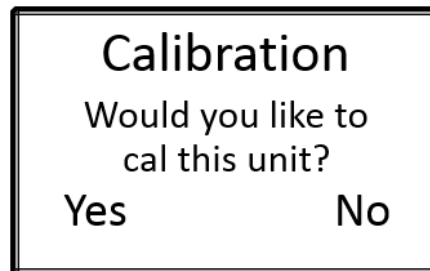

1. Press the **ADD** button to select “Yes” to begin the calibration process and to advance to the calibration confirmation screen. If you do not wish to calibrate the sensor, press the **SUB** button to select “No” to advance to the sensor radio address setting screen.

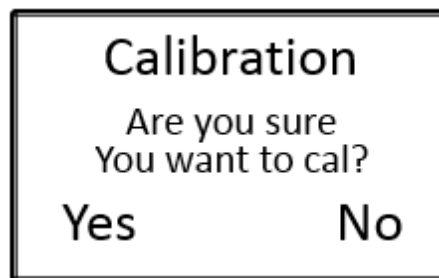

2. Press the **ADD** button to select “Yes” to confirm that you want to calibrate the sensor and to continue to the concentration setting screen. If you do not wish to continue to calibrate the sensor, press the **SUB** button to select “No” to advance to the sensor radio address setting screen.

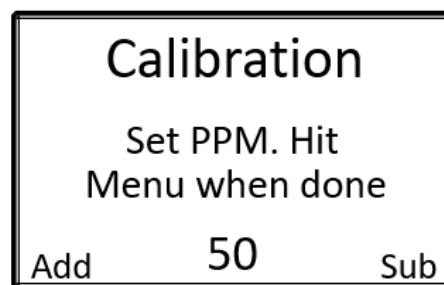

3. Use the **ADD** and **SUB** buttons to adjust the concentration to the calibration gas being used. Press the **MENU** button to save the gas concentration setting and to advance to the calibration start screen.
4. Affix a Calibration Cup Kit (sold separately) to the sensor housing of the device.
5. Affix a regulator to the calibration gas bottle.

6. Attach the tubing on the Calibration Cup Kit to the regulator on the calibration gas bottle.

Calibration  
Apply gas then  
hit menu button

7. Ensure that the gas is flowing and press the **MENU** button to begin calibrating the sensor, the unit will automatically begin the calibration process, the amount of time on the timer will vary based on the gas type. During calibration, the display will show a countdown of the time remaining until the process is complete.

Calibration  
It will be caled  
At the end of timer  
**120**



## NOTICE

Once the calibration countdown has started, the process cannot be stopped without disconnecting the batteries.

8. When calibration is complete, detach the Calibration Cup Kit from the sensor housing and reattach the rain guard. Press the **MENU** button to advance to the sensor Radio Address screen.

Calibration  
Unit is now caled  
to 50 PPM.  
Reading: 50

## 4.3 SENSOR RADIO ADDRESS

The OI-6900 radio address is adjustable from 1 to 255, each sensor assembly on the network needs a unique radio address in order to avoid a fault at the receiving monitor. The default radio address is 1.

### 4.3.1 SENSOR RADIO ADDRESS SETTING

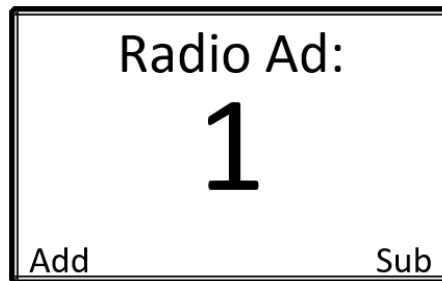

1. Use the **ADD** and **SUB** buttons to increase and decrease the sensor radio address, respectively.
2. Press the **MENU** button to save the desired setting and to exit the operation settings menu, and to return the device to normal operating mode.



## 5 PRODUCT MAINTENANCE

### 5.1 SCHEDULED MAINTENANCE

Otis recommends that our equipment be calibrated a **MINIMUM** of every 90 days, and **STRONGLY** advise that calibration be performed every 30 days. Without knowing the specific application, sensor assembly location, gas exposure, and other factors, the company recommends monthly calibrations – assuming no damage or potential damage has occurred to the sensor and that there has not been a power outage to the sensor assembly. If damage has occurred or the power supplied to the sensor has changed, a calibration should be completed immediately.

Scheduled maintenance should include the null and calibration of the sensor and a relay test. Consult the Sensor Calibration and Relay Test sections of this manual for further information and instructions on how to perform these procedures.

The sensor head and rain guard should be kept free of airborne particles, dirt, mud, spider webs, bugs and insects, and/or any other debris that could potentially cover or coat the sensor. Keeping the sensor head and rain guard clear of foreign articles will allow for proper operation of the device. A brief inspection during scheduled maintenance should suffice, but dependent upon the location and the environment in which the unit is installed, more frequent inspections may be warranted.

The sensor assembly may be adversely affected by the exposure to certain airborne substances. Loss of sensitivity or corrosion may be gradual, if such materials are present in sufficient concentrations. The performance of the device may be impaired during operation in the presence of substances that can cause corrosion on gold plating. Other inhibiting substances are those that can coat the internal walls of the optical chamber and reduce reflectivity. These include, but are not limited to, heavy oil deposits, dust/powder, water condensation, and salt formation. Continuous and high concentrations of corrosive gases may also have a detrimental long-term effect on the product's service life. The presence of such substances in an area does not preclude the use of this device, but the likelihood of the shortened lifetime of the sensor element, as a result, should be noted. Use of the sensor assembly in these environments may require more frequently scheduled maintenance to ensure safe and reliable system performance.

## 5.2 SENSOR REPLACEMENT

The sensor elements used in the OI-6900 detects gas in either % or PPM concentrations, this element must be fully functional in order for the system to operate correctly. Otis recommends replacing the sensing element whenever a slow response to gas is observed during the normal calibration process. After replacing the sensing element the device **MUST** then be nulled and calibrated for proper operation of the device.



### CAUTION

- ◆ The internal components can be static sensitive. Use caution when opening the enclosure and handling internal components.
- ◆ **DO NOT** use any metal objects or tools to remove the sensing element from the sensor adapter board.

1. **Press and hold** the **SUB** button for approximately 6 seconds, until “OFF” shows on the display screen.
2. Unscrew and remove the sensor housing cap from the sensor housing base. Set aside.
3. Using the thumb and forefinger, gently unplug the sensing element from the sensor housing board.

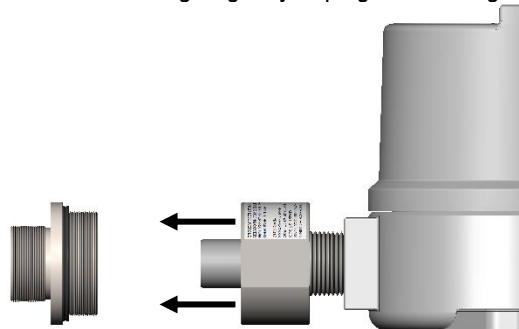

4. Plug in the new sensing element into the sensor housing board. Ensure that the pins on the sensing element align with the sockets on the sensor housing board.

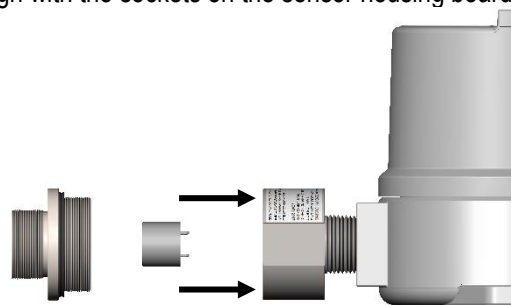

5. Screw the sensor housing cap back onto the sensor housing base, ensuring that the sensor housing cap is only tightened hand tight.

## 5.3 BATTERY REPLACEMENT

The OI-6900 will operate for up to two years with normal usage, the presence of gas will increase the radio transmission rate and decrease this battery lifetime. It is recommended that the batteries be replaced when the voltage reported is 3.0 volts or less. To determine the battery voltage you can reference the **Product Information** section of this manual. When replacing the batteries they **SHOULD** be replaced in pairs and you should **NEVER** mix old and new batteries. The OI-6900 is able to operate with only one battery, however, the runtime of the unit will be reduced. After replacing the batteries it is **STRONGLY** suggested that the sensor assembly be nulled and calibrated for proper operation of the device.



### CAUTION

- ◆ **DO NOT** replace the batteries in a hazardous area, always remove the sensor assembly to a safe area.
- ◆ The internal components can be static sensitive. Use caution when opening the enclosure and handling internal components.
- ◆ **DO NOT** use any metal objects or tools to remove the terminal board from the internal system.
- ◆ **DO NOT** mix old and new batteries.

1. **Press and hold** the **SUB** button for approximately 6 seconds, until “OFF” shows on the display screen.
2. Remove the enclosure lid, unscrewing it from the device enclosure. Set aside.
3. Gripping the front panel thumbscrews, lift the internal system out of the enclosure and rest it against the rim of the enclosure opening.



### NOTICE

Disconnecting the sensor connector plug from the sensor housing connector and the antenna fitting cable will allow for the complete removal of the internal system from the device enclosure. Disconnecting the internal system may provide ease in accessing the control board terminals for connecting the battery plug into the battery connectors. If this step is performed, it is essential that all connections are rejoined before returning the internal system back into the enclosure.

4. Locate the battery connectors on the terminal board assembly. Squeeze the locking tab on one battery plug and gently pull it straight out of the battery connector. Repeat this step for the second battery plug and connector.

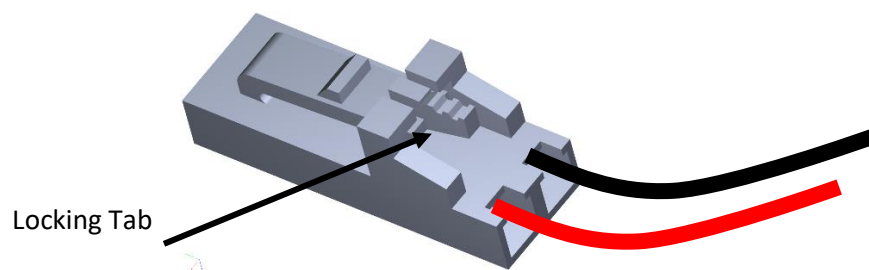

5. Gently remove the batteries from the battery spring clips.

6. Gently slide the new batteries into the spring clips, orienting them in the same general way as the batteries that were removed.
7. Plug the battery on the bottom of the radio board into the closer 2-pin battery terminal.
8. Plug the battery on the top of the radio board into the other available 2-pin battery terminal.
9. Place the internal system back into the device enclosure, matching each mounting post to its corresponding eyelet anchored within the base of the enclosure.
10. Using the thumbscrews, gently push to seat the internal system into the mounting posts.



## NOTICE

The thumbscrews on the OI-6900 function **ONLY** as thumb-holds for ease in removal of the internal system from the base of the enclosure. Do **NOT** attempt to loosen or tighten the thumbscrews when opening or closing the enclosure.

11. Verify that the sealing ring, seated at the threaded opening of the device enclosure, is correctly in place.
12. Affix the glass enclosure lid back onto the device, rotating the lid until it is tightly screwed into place.
13. The unit will start in **OFF** mode, press the **ADD** button to initiate the 1-minute startup countdown.

## 5.4 PRODUCT TROUBLESHOOTING

OI-6900 Fault Codes		
Problem	Cause(s)	Solution(s)
<b>F4</b> Check Sensor Board	1. The control board has lost communication with the sensor element or sensor housing.	1. Replace the sensor element. 2. Replace the sensor housing.
<b>F5</b> Try to Null Again	1. The unit did not null correctly, due to: <ul style="list-style-type: none"> <li>• the presence of gas,</li> <li>• a sensor error, or</li> <li>• an analog sensor board error.</li> </ul>	1. Re-null the device in clear air. 2. Replace the sensor element. 3. Replace the sensor housing.
<b>F6</b> Try to Calibrate Again	1. The unit did not calibrate correctly, due to: <ul style="list-style-type: none"> <li>• the absence of gas,</li> <li>• a sensor error, or</li> <li>• an analog sensor board error.</li> </ul>	1. Recalibrate the sensor element and verify that gas is present during calibration. 2. Replace the sensor element. 3. Replace the sensor housing. 2. If it happens frequently, or continues to fault, replace the sensor element. 3. Replace the sensor housing.
<b>F14</b> Check Radio	1. The sensor assembly has lost communication with the Primary Monitor <ul style="list-style-type: none"> <li>• Network ID is incorrectly configured.</li> <li>• Sensor assembly is obstructed/too far from the Primary Monitor.</li> <li>• Radio module is not working in the sensor assembly</li> </ul>	1. Check that the Network ID on the sensor assembly matched the Primary Monitor Network ID 2. Move the sensor assembly away from the obstruction or use a high gain antenna. 3. Replace sensor radio module.

When replacing the sensor element, the detector must be nulled and calibrated. System faults will activate the fault terminal at the monitor.

## 5.5 PRODUCT REPLACEMENT PARTS AND ACCESORIES

While not all of the components on the OI-6900 can be field-replaced, there are several parts that are replaceable by an Otis Approved Service Technician.

To purchase accessories/replacement parts for your device, contact the sales representative of this product for assistance.

<b>OI-6900 Product Replacement Parts and Accessories</b>	
<b>External Replacement Parts</b>	
<b>Part Name</b>	<b>Otis Part Number</b>
Main Enclosure with Lid	OI-4980
Sensor Housing Base	OI-2700-BASE-GRPB
Sensor Housing Cap with Flame Arrestor	OI-2000-CAP-ASSY
Enclosure Lid	OI-4980-LID
Sensor Rain Guard	OI-500-B
Antenna Fitting	OI-AF-RXN
900 MHz Antenna	OI-AN-900-FLEX-R
2.4 GHz Antenna	OI-AN-2.4-RIGID-S
<b>Internal Replacement Parts</b>	
<b>Part Name</b>	<b>Otis Part Number</b>
Control board	OI-6900-CB-2B-PCA
Radio Board with no radio module	OI-6900-RB-2B-PCA
GEN II 900 MHz Radio Module	OI-RADIO-900-LAIRD
GEN II 2.4 GHz Radio Module	OI-RADIO-2.4-TH
Photo Ionization Detector Analog Sensor Board (Sensor Element Sold Separately) <i>*Specify PPM Scale When Ordering (10, 20, 50, 1K, or 2K)</i>	OI-2014B-XX*
Electrochemical Analog Sensor Board (Sensor Element Sold Separately) <i>**Specify Gas Type When Ordering</i>	OI-2015-SB-NEC**
Oxygen Analog Sensor Board (Sensor Element Sold Separately)	OI-2016-SB-O2
Dynamment Lower Power IR Analog Sensor Board	OI-2020-SB-IRLP2
<b>Product Accessories</b>	
<b>Part Name</b>	<b>Otis Part Number</b>
Otis Magnetic Tool	OI-420
Calibration Cup Kit	OI-410
Replacement Filter for Dusty Environments	OI-2000-CAP-FILTER
Replacement Sensor Housing Cap O-Ring	OI-2000-ORING
Replacement Main Enclosure O-Ring	OI-449

## APPENDICES

- APPENDIX A: OTIS INSTRUMENTS PRODUCT WARRANTY STATEMENT
- APPENDIX B: INFORMATION ABOUT RMA SERVICE REPAIRS
- APPENDIX C: INFORMATION ABOUT RMA RETURNS FOR CREDIT

## APPENDIX A: PRODUCT WARRANTY STATEMENT

### Warranty Coverage

Otis Instruments, Inc., 301 S. Texas Avenue, Bryan, Texas, 77803 (“Otis”) warrants the manufacture of all Otis hardware, firmware, software, components, and product accessories (“Otis Products”), contained in the original packaging, against defects in materials and workmanship when used normally in accordance with Otis’ published guidelines for a period of ONE (1) YEAR from the date of original purchase by the end-user/purchaser from the manufacturer or from the product’s authorized sellers/distributors (“Warranty Period”). Otis’ published guidelines include but are not limited to information contained in technical specifications, operation/user manuals and service communications.

### Warranty Exclusions

This Warranty does not apply to any non-Otis manufactured products, even if packaged or sold with Otis Products. Otis does not warrant that the operation of their manufactured products be uninterrupted or error-free. Otis is not responsible for damage arising from failure to follow instructions relating to the Otis Product’s use.

This Warranty does not apply to: (a) batteries; (b) protective coatings that are designed to diminish over time, unless failure has occurred due to a defect in materials or workmanship; (c) cosmetic damage, including scratches, dents and chipping of paint; (d) damage, caused by use with another product accident, abuse, misuse, or any external cause of force majeure; (e) damage, caused by operations outside of Otis’ published guidelines; (f) damage, caused by service performed by anyone who is not a representative of Otis or who is not an Otis authorized service provider; (g) damage, caused by product modifications, alterations of functionality or capability; (h) defects, caused by normal wear and tear or otherwise due to the normal aging of the Otis product, or (i) any product in which a product-labeled serial number has been removed, defaced, or altered in any way.

If examination and assessment discloses that the alleged defect in the product does not exist, or was caused by the end-user/purchaser (or any third-party) misuse, neglect, improper wiring or installation, testing or calibrations, the Otis Product Warranty will be null and void. Any unauthorized attempts of repair, modification, or any other cause of damage beyond the range of the Otis Product’s intended use, including force majeure, voids all liability of the manufacturer.

### Replaceable Batteries and Sensor Elements

All batteries supplied to the end-user/purchaser by Otis are covered, from the date of shipment, for ninety (90) days, unless otherwise excluded and noted†. Sensor elements supplied to the end-user/purchaser by Otis have individual Warranty information, regarding Product Lifetime and Warranty. For more information on sensor element Warranties, refer to the Otis published guidelines.

### End-User Responsibilities

End-user/purchaser should perform periodic null and calibration procedures, recommended every thirty (30) days, not to exceed ninety (90) days, for optimal performance, proper maintenance, and as a precaution against possible operational failures.

Before the end-user/purchaser receives the initial Warranty service, Otis may require the end-user to furnish proof of purchase details, respond to questions designed to assist with diagnostics, and follow Otis procedures for obtaining Warranty service.

For Otis Products that feature data logging and data storage, the end-user/purchaser should generate a separate backup copy of the information contained on the device, before submitting the Otis Product for Warranty service. Otis Warranty service is not responsible for any loss of data or settings stored on the device while under service/repair.



Otis Products submitted to Warranty service must be returned in their complete assembly, as originally shipped from the manufacturer. Warranty service will not service/repair Otis Products that are not in their original condition. For Otis Gas Detection Products, also referred to as Sensor Assemblies, the end-user/purchaser must remove external antenna(s), rain guard(s), and all batteries before shipping.

Otis Products submitted to Warranty service will be returned, as originally configured, with the factory default settings, upon completion of the service/repair. Otis is not responsible for maintaining end-user/purchaser settings, resetting the null, recalibration, or any other preparations for reinstallation and/or reintegration of the device.

### **Warranty Service**

Please refer to the Otis published guidelines and/or the Otis website before seeking Warranty service. If the Otis Product continues to malfunction/error after consulting these resources, please contact the product's authorized seller/distributor or consult the Otis RMA/Service webpage at [www.otisinstruments.com/service](http://www.otisinstruments.com/service) for information and instructions on submitting the Otis Product for Warranty service.

Otis Warranty service, at their discretion, will (a) repair the device using new or previously used parts that are equivalent to new in performance and reliability, (b) replace the Otis Product with a device that is at least functionally equivalent to the Otis product and is formed from new and/or previously used parts that are equivalent to new in performance and reliability, or (c) exchange the Otis Product for a refund of your purchase price, when an Otis Product is submitted.

Otis Warranty service will treat service/repairs as quick-turn exchanges. Otis Warranty service does not replace any board level components, (i.e. magnetic switches, resistors, capacitors, relays, etc.).

Otis Products may require the replacement of certain user-installable parts or Otis Products. A replacement part or Otis Product, including a user-installable part that has been installed in accordance with instructions provided by Otis, assumes the remaining term of the Warranty, or ninety (90) days from the date of replacement or repair, whichever provides the longer coverage for the end-user/purchaser. When an Otis product or part is replaced, or a refund is provided, any replacement item becomes your property and the replaced or refunded item becomes Otis' property.

For Otis Products requiring Warranty service that are located outside of the United States, the customer is responsible for compliance of all import/export laws and regulations/requirements, including associated taxes and other charges. Where applicable, Otis Warranty service may repair/replace products with parts that comply with local/regional standards.

Otis Products covered under Warranty will receive service/repairs at no charge to the end-user/purchaser. Otis Products not under Warranty will be diagnosed for service/repair and the end-user/purchaser will be notified of the recommended service/repairs and applicable charges. The completion of the service/repairs, or the return of the unrepaired product, is at the discretion of the end-user/purchaser. Charges assessed for service/repair on Otis Products not under Warranty are at a rate of list cost minus dealer/distributor percent discount.

Upon completion of Warranty service, Otis Warranty service will return the device to the end-user/purchaser. Please consult the Otis website for more information concerning shipping costs for Warranty service.

Otis reserves the right to change the method by which Otis Warranty service is provided. Otis also reserves the right to change the Otis Product's eligibility to receive a particular method of service. Warranty service may be limited for Otis Products in the country where the manufacturer or product's authorized sellers/distributors originally sold the product. Warranty service options, parts availability and response times may vary.

(†) Battery for the GEN II Model OI-6940 "The Quad" WireFree Explosion-Proof Battery-Powered Multi-Gas Detector is excluded from the ninety (90) day warranty policy.

## APPENDIX B: INFORMATION ABOUT RMA SERVICE REPAIRS

*Otis Instruments, Inc. offers technical support to our customers. Please contact the Otis Instruments RMA Service Department for technical support, repair requests, warranty inquiries, end-user commission reports, dealer/distributor support, and Modbus setup inquiries and services.*

*This appendix is for information purposes only. Please visit our website at [www.otisinstruments.com/RMA](http://www.otisinstruments.com/RMA) to obtain the latest version of the Otis Instruments, Inc. Return Material Authorization (RMA) Service Repair Form and shipment instructions.*

### IMPORTANT INFORMATION

All RMA Service repairs must be shipped to OTIS Instruments / Repairs, 301 South Texas Ave., Bryan, Texas 77803.

To ensure that RMA Service repairs are processed as timely as possible, the Otis Instruments, Inc. Return Material Authorization (RMA) Service Repair Form must be completed in its entirety and included within the box at the time of shipment. Customer contact information and product information, including model number, serial number, and specific reason(s) for service, will need to be accessible in order to complete the form. Shipments received that do not include the form, or if the form is incomplete, will be returned (unrepaired) COD to the customer.

Products/parts must be shipped in the proper packaging and the shipping materials must adhere to ESD safety precautions, as applicable. The entire assembly, as originally shipped from the manufacturer, must be returned for repair. When shipping sensor assemblies (gas detectors), the antenna, rain guard, and battery must be removed prior to shipment. Failure to adhere to these instructions will result in the products/parts being returned to sender.

Once the RMA Service Repair Form is received by the Otis Instruments RMA Service Department, a RMA Service number will be generated. The RMA Service number will be sent to the email address provided for verification of receipt.

RMA Service quotes have a thirty (30) day expiration. Quotes that do not receive a purchase order response within thirty (30) days of the quote will be canceled and all products/parts will be returned (unrepaired) COD to the customer.

Discontinued products may not be returned for RMA Service for repair. For a listing of the Otis Instruments, Inc. discontinued products, please visit our website at [www.otisinstruments.com/RMA](http://www.otisinstruments.com/RMA). If your product/part has been discontinued, please contact your local sales representative for replacement options.

All RMA Service repairs are treated as quick-return exchanges. Otis Instruments, Inc. does not replace board level components (i.e. magnetic switches, resistors, capacitors, relays, etc.).

There is no charge for RMA Service repairs that are within the specified warranty period. For a copy of the Otis Instruments, Inc. Product Warranty Statement, please visit our website at [www.otisinstruments.com/official\\_statements](http://www.otisinstruments.com/official_statements). Products/parts that are not within the specified warranty period will result in a charge to the customer for service.

Products/parts that fall within the Otis Instruments, Inc. operating specifications deemed defective due to customer misapplication will be returned as is, and may result in a per unit evaluation fee to the customer. Otis Instruments, Inc. reserves the right to return customer-damaged or no-fault found products/parts from the Otis Instruments RMA Service Department COD to the customer.

If advanced replacement is required, please contact the Service Department for more information.

## INTERNATIONAL RMA SERVICE REPAIRS

The customer is responsible for complying with all import/export requirements for shipment of RMA/Service repairs to Otis Instruments, Inc.

## OTIS INSTRUMENTS RMA SERVICE DEPARTMENT

Otis Instruments / Repairs  
301 South Texas Ave.  
Bryan, Texas 77803  
Office: 979.776.7700  
Fax: 979.776.7719  
[service@otisinstruments.com](mailto:service@otisinstruments.com)  
[www.otisinstruments.com/RMA](http://www.otisinstruments.com/RMA)

## APPENDIX C: INFORMATION ABOUT RMA RETURNS FOR CREDIT

*Without exception, all RMA Returns for Credit to Otis Instruments, Inc. must receive prior approval before shipment. Otis Products received that do not have prior approval will be returned (uncredited) COD to the customer. For inquiries and approval for RMA Returns for Credit, please contact your local sales representative.*

*This appendix is for information purposes only. Please visit our website at [www.otisinstruments.com/RMA](http://www.otisinstruments.com/RMA) to obtain the latest version of the Otis Instruments, Inc. Return Material Authorization (RMA) Return for Credit Form and shipment instructions.*

### IMPORTANT INFORMATION

All RMA Returns for Credit must be shipped to OTIS Instruments / RMA Returns, 301 S. Texas Avenue, Bryan, Texas 77803.

Product/part returns must be in their original condition and packaging, as shipped from the manufacturer. Returns that do not meet these specifications will be rejected for return for credit. Otis Instruments, Inc. reserves the right to return products/parts deemed to be inadequate (uncredited) COD to the customer.

To ensure that Returns for Credit are processed as timely as possible, the RMA Return for Credit Form must be completed in its entirety and included within the box at the time of shipment. Customer contact information and product information, including model number, serial number, and specific reason(s) for service, will need to be accessible in order to complete the form. Shipments received that do not include the form (or if the form is incomplete) will be returned (uncredited) COD to the customer.

Once the shipment is received by the Otis Instruments RMA Returns Department, a RMA number will be generated. The RMA number will be sent to the email address provided for verification of receipt.

All RMA Returns for Credit will be processed for approval by the manufacturer.

A restocking fee of 15% will be charged for all products/parts returned to the manufacturer.

Discontinued products may not be returned for credit. For a listing of Otis Instruments, Inc. discontinued products, please visit our website at [www.otisinstruments.com/RMA](http://www.otisinstruments.com/RMA). If your product/part has been discontinued, please contact your local sales representative for replacement options.

### INTERNATIONAL RMA SERVICE REPAIRS

The customer is responsible for complying with all import/export requirements for shipment of RMA/Service repairs to Otis Instruments, Inc.

### OTIS INSTRUMENTS RMA RETURNS DEPARTMENT

Otis Instruments / RMA Returns  
301 S. Texas Avenue  
Bryan, Texas 77803  
Office: 979.776.7700  
Fax: 979.776.7719  
[service@otisinstruments.com](mailto:service@otisinstruments.com)  
[www.otisinstruments.com/RMA](http://www.otisinstruments.com/RMA)









## **Otis Instruments**

301 S. Texas Avenue, Bryan, Texas 77803

Tel: 979.776.7700 Fax: 979.776.7719

[sales@otisinstruments.com](mailto:sales@otisinstruments.com)

[service@otisinstruments.com](mailto:service@otisinstruments.com)

[www.otisinstruments.com](http://www.otisinstruments.com)