



OI-315 TOCSIN³ CO Cockpit Monitor

Operation Manual

Revision 2.1



Table of Contents

Introduction	4
Complete System Diagram	4
Complete System	4
LCD Display Symbols	5
Power On	6
Power Off	6
Basic Operation	7
Gas Measure Mode	7
LCD Backlight On/Off	7
Viewing Date and Time	7
Setting Date and Time	8
Alarms and Indicators	9
Setting Alarms	9
Alarm Displays	10
Alarm Indicators	10
Returning to Normal Operating Mode Following a Low Alarm	10
Returning to Normal Operating Mode Following a High Alarm	11
Indication of Peak Value and STEL / TWA Value	11
Battery Notifications	11
Data Logging (Alarm Data)	12
Fresh Air Calibration	13
Battery Replacement	14
User Notice	16
Approval Label Notes	16
Specifications	17
Carbon Monoxide Poisoning Symptom Guide	18
Warranty Statement for the Model OI-315	19

Introduction

This document is an Operation Manual containing diagrams and step-by-step instructions for proper operation of the Otis Instruments, Inc. Model OI-315 TOCSIN³ CO Cockpit Monitor. This document should be read before initial operation of the product.

Should a question arise during the use of the product, this document will serve as a first reference for consultation. If further questions arise, or if the device is not working properly, please contact the sales representative of this product.

Complete System Diagram

The following diagrams should be consulted for identification of the system and all parts that may be referred to in this operation manual.

Complete System

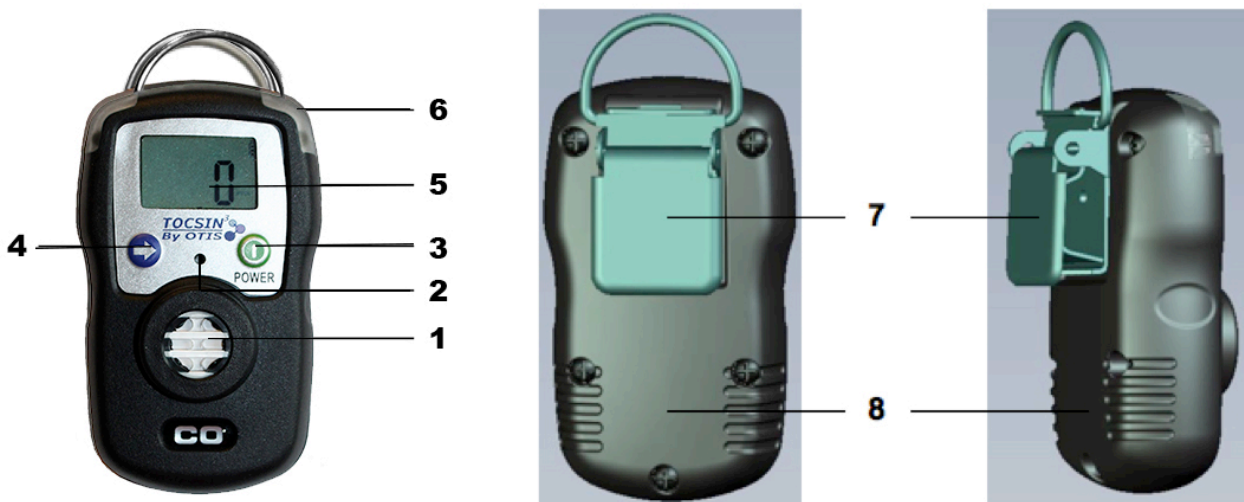

1	Gas sensor
2	Buzzer
3	Green power button
4	Blue arrow button
5	LCD display screen
6	Alarm LED
7	Belt clip
8	Type label

LCD Display Symbols



	Alarm		Date
	First Alarm		Month
	Second Alarm		Time
	Safety Success		Log Value
	Safety Failure	TWA	Time Average Level Alarm
	Fresh Air Calibration	STEL	Time Average Level Alarm
	Standard Gas Calibration	MAX	Max Peak Value
	Battery	MIN	Min Peak Value
	Unit		

Power On

To power on the device, press and hold the green power button for approximately three seconds.

When powered on, the device will vibrate, flash, and sound an audible alarm to verify that those features are active. After a 10 second countdown, a “V” icon will flash on the display screen and the current level of measured gas in ambient air will be shown. When in Gas Measure Mode (Normal Operating Mode), the “V” icon will disappear (after blinking several times).

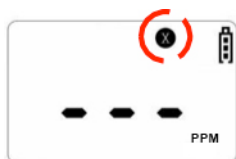
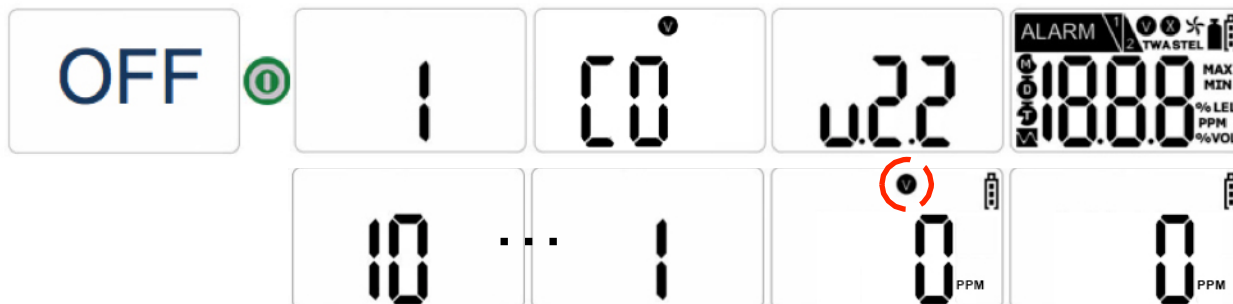

NOTE: In the event that stabilization of the device fails, Gas Measure Mode will not be entered. Instead, a blinking “X” will appear on the display screen. The “X” indicates that calibration of the sensor, or aftercare of the instrument, is required.

Power Off

To power off the device, press and hold the green power button for approximately three seconds. The display screen will countdown the number of seconds remaining until the device is “OFF.”



NOTE: If the green power button is pressed while the device is not in Gas Measure Mode, or if the green power button is not held down for the required amount of time for powering off the device, the device will remain on.

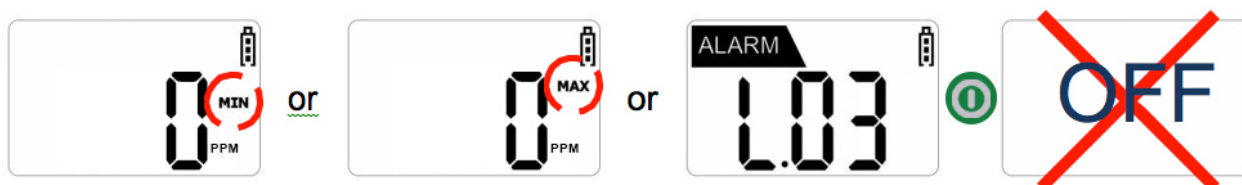

Basic Operation

NOTE: Appropriate calibration of the device is required prior to operation. Always ensure that the device makes the proper detection response to the pertinent gas. Verify that foreign materials that could interfere with the detection of gas are not blocking the area where gas is to be detected.

Gas Measure Mode



Gas Measure Mode is the normal operating mode of the OI-315. When in Gas Measure Mode, the concentration of CO and remaining battery life are displayed on the screen.

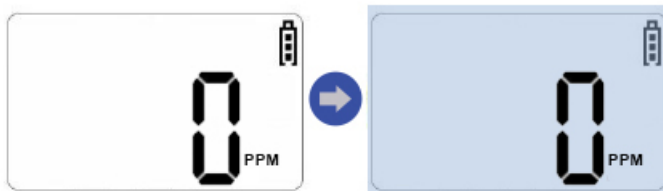

LCD Backlight On/Off

To turn on the LCD backlight, press the blue arrow button while in Gas Measure Mode. To turn off the LCD backlight, press the blue arrow button again (or wait approximately 25 seconds for the backlight to turn off automatically).

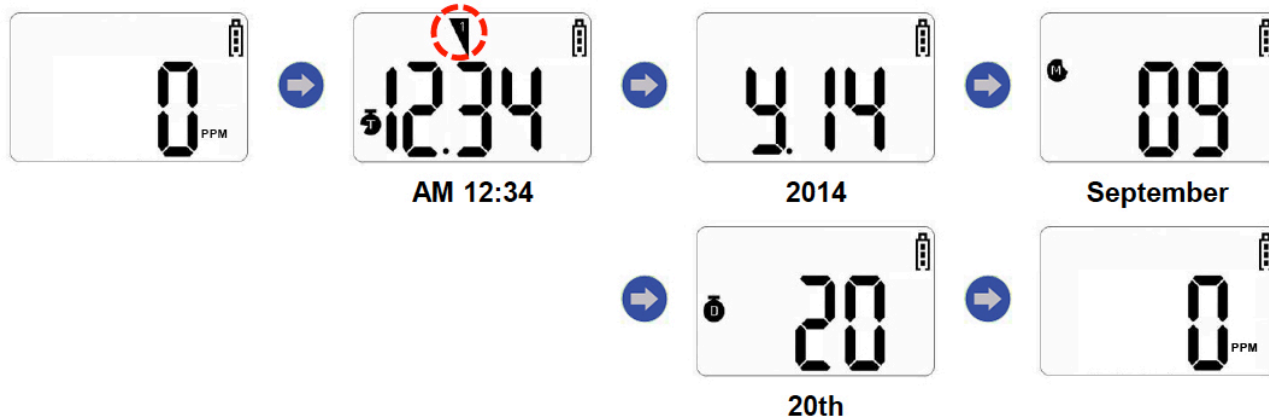

Viewing Date and Time



1. Press and hold the blue arrow button for three seconds (while in Gas Measure Mode).
2. When the  icon is displayed on the screen, quickly press the blue arrow button. The preset time ( = a.m. and  = p.m.), year, month, and day are sequentially confirmed (displayed with the icon or character equivalent of it) with each additional press of the blue arrow button.
3. Press the green power button to return to Gas Measure Mode (or wait several seconds for the device to automatically return).

Setting Date and Time

1. Press and hold the blue arrow button for three seconds (while in Gas Measure Mode).
2. When the  icon is displayed on the screen, press and hold the green power button for five seconds. The Date and Time Set Mode is displayed and a number will flicker.
3. Press the blue arrow button to change the value (to increase the value quickly, hold down the blue arrow button).
4. Press the green power button to save the value that is displayed on the screen and proceed to the next display.

NOTE: The year value cannot exceed "2030."

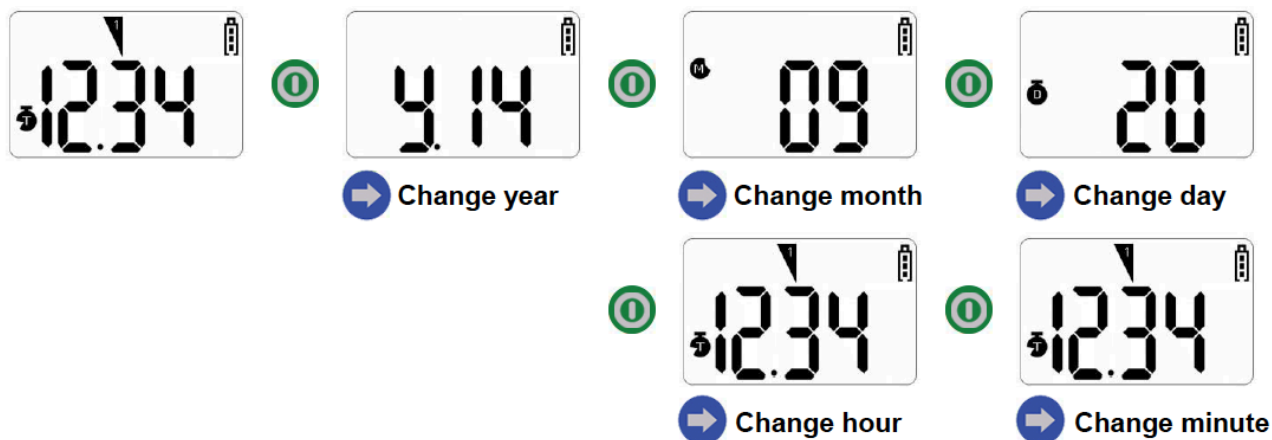

Setting Alarms

The OI-315 TOCSIN³ CO Cockpit Monitor alarm values are preset at recommended settings. Although it is strongly discouraged by the manufacturer, the user is able to modify alarm set points. Default alarm set points are pre-set at:

- Low Alarm = 35 ppm
- High Alarm = 100 ppm

1. Power off the device.
2. To enter Alarm Set Mode, press and hold the blue arrow button for approximately two seconds. The device will enter 1st Alarm Set Mode.

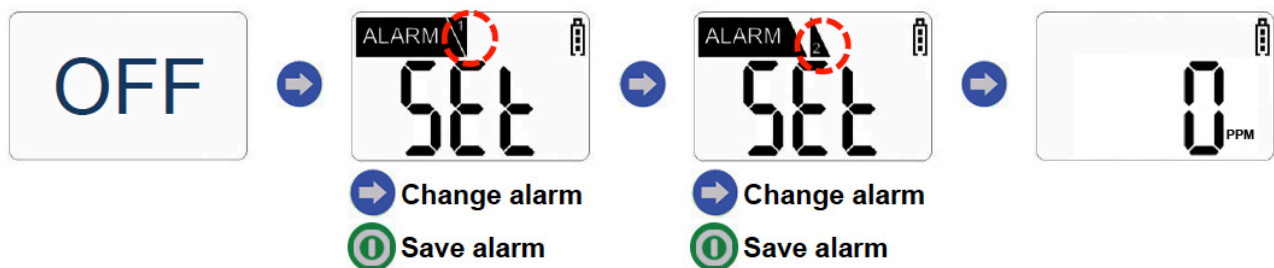





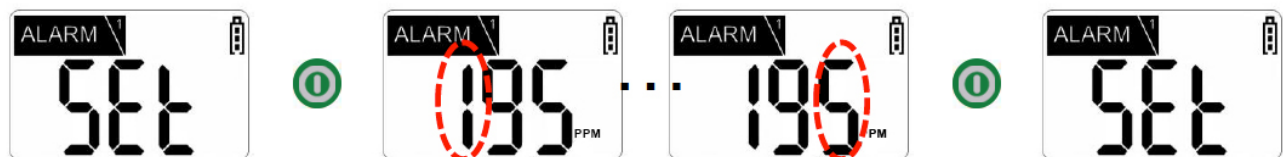



3. To change the Low Alarm setting, briefly press the green power button. The display will indicate the current three-digit Low Alarm setting and the first digit will flash. Press the blue arrow button to increase the digit by one (per press).

NOTE: Each unit value can be set between "0" and "9."

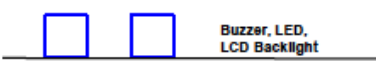

4. Once the desired value is displayed on the screen, press the green power button to save the alarm value (and move to the 2nd Alarm Set Mode). Repeat these steps for the High Alarm.
5. To return to Gas Measure Mode, press the blue arrow button once.

Alarm Displays

Alarm	Alarm Standard	LCD Display	Alarm & Vibration Display
1 st Alarm	In Exceeding Alarm Value Set Primarily	Displaying  Icon & Concentration	
2 nd Alarm	In Exceeding Alarm Value Set Secondly	Displaying  Icon & Concentration	
TWA	In Exceeding Exposure Concentration for 8 hour	Displaying Icon TWA & Concentration	
STEL	In Exceeding Exposure Concentration for 15 minutes	Displaying Icon STEL & Concentration	
Dead Battery	Battery Capacity is Exhausted.	 Blinking of Battery	
Test Failure	Failure of Sensor Test Failure of Calibration	Displaying  Icon	

Alarm Indicators

If the concentration of gas changes, the value of concentration will be indicated on the display screen in real-time. If the gas concentration exceeds the present value for the low or high alarm, the measured value of gas and **MIN** or **MAX** icon (respectively) will blink periodically. In addition, an LED notification, audible alarm and vibration will be triggered.

Returning to Normal Operating Mode Following a Low Alarm

To silence the audio alarm briefly while in Low Alarm, press the green power button (the lights and vibration will continue until the reading drops below the Low Alarm limit). Once the device has been moved to a clean-air location, the alarms will stop.

To remove the alarm icon from the display screen following a Low Alarm, press the green power button. This step allows the user to confirm that the area is indeed safe.

Returning to Normal Operating Mode Following a High Alarm

When a High Alarm has been triggered, the audio alarm cannot be silenced and the alarm icon cannot be removed from the display screen by pressing the green power button. To remove the alarm following a High Alarm, the unit must be moved to a clean-air location and power must be cycled (see the Power Off / Power On sections of this operation manual).

Indication of Peak Value and STEL / TWA Value

When a STEL (Short Term Exposure Limit) / TWA (Time Weighted Average) Alarm has been triggered, it is indicated with the **STEL** or **TWA** icon (respectively), value of the measured gas, an LED notification, audible alarm and vibration.

To remove the alarm following a STEL / TWA Alarm, the unit must be moved to a clean-air location and power must be cycled (see the Power Off / Power On sections of this operation manual).

NOTE: All alarm values are set according to the alarm standard of CO gas (that is required by international standards). Therefore, alarm values can be changed only under the responsibility and approval of the administrator of the work site where the instrument is used.

The maximum value, STEL value, and TWA value will be displayed consecutively while in Gas Measure Mode.

Battery Notifications

When the battery level is low (one bar remains on the battery icon), an alarm will sound repeatedly at five minute intervals. When the battery is nearly exhausted, a unique combination of audible, LED, and LCD backlight alerts will display for approximately 10 seconds (before the unit turns off completely).

Data Logging (Alarm Data)

1. Press the green power button four times while in Gas Measure Mode (Data Log Mode is displayed after maximum, STEL, and TWA readings).

NOTE: If an alarm event has not yet been recorded on the device, the Data Log Mode screen will not appear. Instead, the device will return to Gas Measure Mode following the final green power button press.

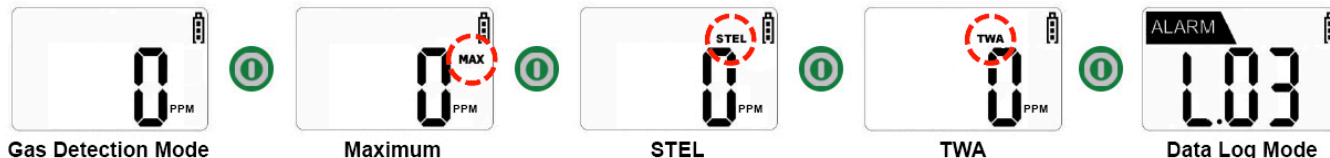

2. Press the blue arrow to enter Data Select Mode. In this mode, data is selected and a record is confirmed.
3. Press the green power button to confirm the year, month, day, time and alarm of the recorded event.
4. To return to the Data Select Mode, press the blue arrow button while the year, month, day, and time are shown on the display screen. To return to Gas Measure Mode, press the green power button.

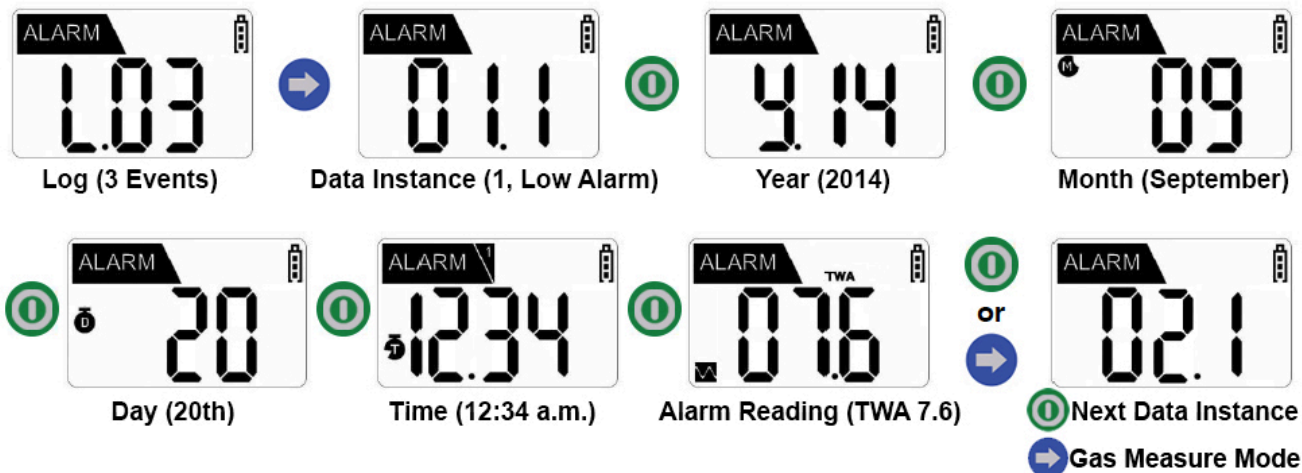

EXAMPLE: In the reading “L.03” the “L” indicates Log and “03” indicates the number of data. Therefore, in the reading “L.03” there are three events that have been logged.

In Data Select Mode, with “01.1” displayed on the screen, “01” indicates the data instance and “1” indicates the type of alarm that occurred (1 = Low Alarm, 2 = High Alarm). Therefore, in the three instances of data that occurred, the first instance was of a Low Alarm.

To view the second, third, etc. sets of recorded data, press the blue arrow button. After the last data reading has been displayed, press the blue arrow button to return to Gas Measure Mode.

NOTE: Up to 20 data events can be stored on a device. Once 20 events are stored, data is removed automatically in the order that it was received (starting at Event 1).

Fresh Air Calibration

NOTE: Initial calibration is performed on all devices prior to shipment. Once received, calibration should be performed monthly (or quarterly) depending on frequency of use.

NOTE: Calibration should be performed in a fresh-air environment that is free from any influence of other gases (since calibration is assumed to be performed in an environment with a concentration of 20.9% Oxygen). It is also recommended that calibration be performed in a space that is not enclosed.

1. To enter Fresh Air Calibration Mode, press and hold the blue arrow button. While holding down the blue arrow button, quickly press and hold the green power button. After approximately three seconds, the display screen will show “CAL” and a ✨ icon will appear and flash.
2. Press the green power button to begin calibration. When calibration begins, a countdown (starting at 10) will appear on the display screen. Once completed, a “V” icon will blink several times on the display screen (as shown circled in red below). Then, the device will return to Gas Measure Mode.

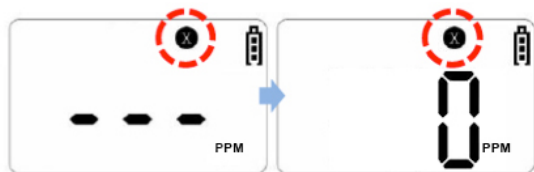
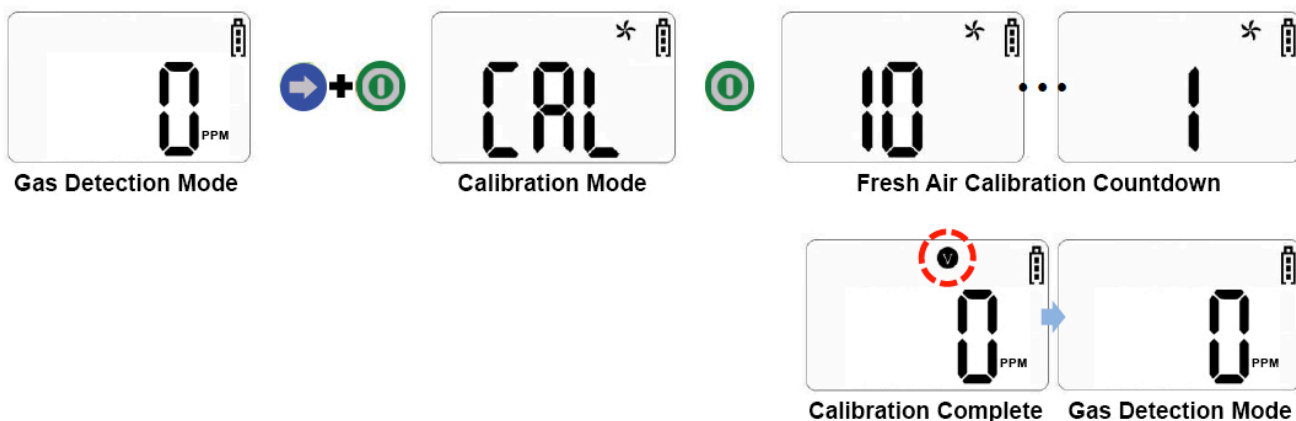

NOTE: If the device fails to enter Calibration Mode, an “X” icon will appear on the display screen. If this continues, please contact the sales representative of this product.

Battery Replacement

When the battery level is low (one bar remains on the battery icon), an alarm will sound repeatedly at five minute intervals. When the battery is nearly exhausted, a unique combination of audible, LED, and LCD backlight alerts will display for approximately 10 seconds (before the unit turns off completely).

Required Items:

- Phillips-head Screwdriver
- Replacement Battery = OI-315-BATT (CR2, Lithium battery, 3V)

NOTE: Replacement of the battery in dangerous regions with potential for explosion is strictly prohibited. Replacement of components can hinder intrinsic safety function.

NOTE: Replacement battery kits should be purchased from the same retailer that the device was originally purchased from.

NOTE: Before disassembling, power off the device according to the instructions in this operation manual.

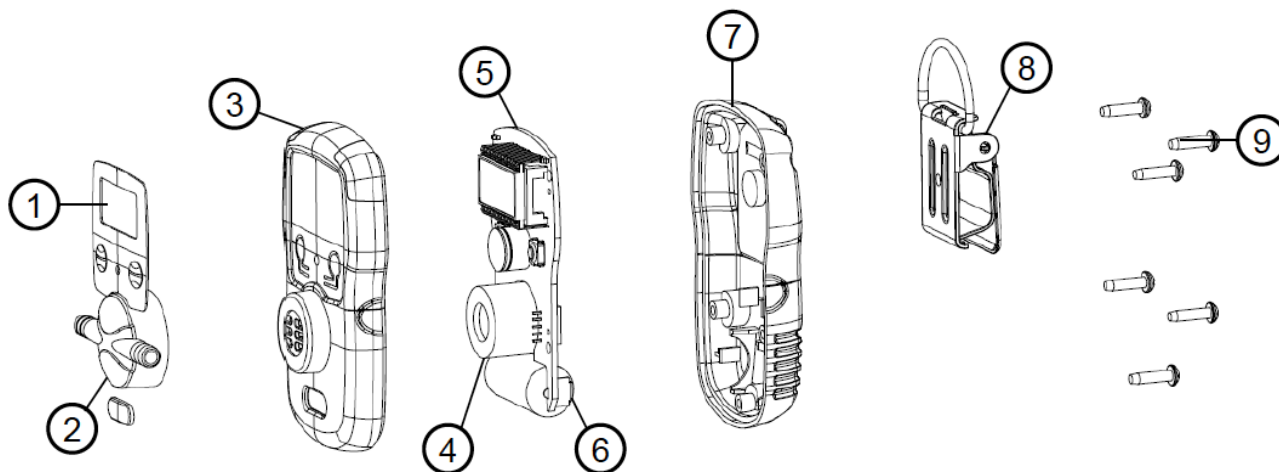

1	Label
2	Calibration cap
3	Front cover
4	Sensor element
5	PCB (terminal board)
6	Battery
7	Rear cover
8	Belt clip
9	Machine screw

1. Remove the five machine screws located on the rear cover of the device.
2. Separate the rear cover from the front cover by gently pulling them away from each other.
3. Using your thumb and forefinger, pull the battery out of the terminal board.
4. Slide a new battery into the terminal board.
5. Verify that the “+” and “-” sides of the battery are facing the correct direction (and touching the battery contacts on the terminal board).
6. Place the front and rear covers together, then replace the five machine screws.



User Notice

The OI-315 should be used in the range of the applicable temperature, humidity and pressure that are listed in the Specifications section of this operation manual. Using the device beyond this range may cause the device to malfunction.

Gas concentration measurements by the sensor can vary according to the environment (temperature, pressure and humidity). Therefore, calibration of the OI-315 should be performed in the same (or similar) environment of the device's actual use.

If the temperature changes sharply during use of the instrument (e.g., indoors vs. outdoors), the value of the measured gas concentration can suddenly change. Please use the OI-315 after the gas concentration value has stabilized.

Severe vibration or shock to the device may cause a sudden reading change. Please use the OI-315 after the value of gas concentration has stabilized. Excessive shock to the OI-315 can cause the device and/or sensor to malfunction.

Approval Label Notes



CE marking: Electromagnetic Compatibility
(Directive 89/336/EEC)
Explosion Protection
(Directive 94/9/EEC)

KS marking: Korean Gas Safety for
Explosion Protection

This device is intended to be used in hazardous area Zone 0 within a temperature range of -20 C to +50 C, where gases of explosion group IIC and temperature class T4 may be present.

S/N: Serial Number

Specifications

Measuring Gas:	CO
Measuring Range:	0-500 ppm
Sensor Life:	> 2 years
Response Time:	< 30 sec/90% scale
Accuracy:	+/- 3%/full scale
Resolution:	1 ppm
Measuring Type:	Diffusion
Measuring Method:	Electrochemical
Parameter Control:	Front 2-switch (calibration, maintenance, alarm setting)
Operation Mode Display:	Visual: digital LCD display, red LED Audible: buzzer (90 dB @ 10 cm)
Measuring Value Display:	3-digit LCD display
Alarm Display:	Visual: alarm and status icon, red LED Audible: buzzer
Alarm Level Set:	Programmable within detection range
Data Log:	Event Log: 20 alarm events
Mounting Type:	Belt clip
Programmable Set Modes:	Alarm value (low and high alarm) Date and time Calibration
Operating Temperature:	-20° C to 50° C (-4° F to 122° F)
Operating Humidity:	5% to 95% RH (non-condensing)
Operating Power:	OI-315-BATT (CR2, Lithium battery, 3V)
Battery Life:	1.2 years (8 hours of use per day)
LCD Size:	1.06" W x .69" H (27 mm W x 17.5 mm H)
Dimensions:	2.13" W x 3.58" H x 1.26" D (54 mm W x 91 mm H x 32 mm D)
Weight:	4.23 oz. (120 g) including battery
Approval:	Ex ia IIC T4 IP67 (KGS, ATEX)
Warranty:	One year

Carbon Monoxide Poisoning Symptom Guide

Concentration	Symptoms
35 ppm (0.0035%)	Headache and dizziness within 6-8 hours of constant exposure
100 ppm (0.01%)	Slight headache in 2-3 hours
200 ppm (0.02%)	Slight headache within 2-3 hours; loss of judgment
400 ppm (0.04%)	Frontal headache within 1-2 hours
800 ppm (0.08%)	Dizziness, nausea, and convulsions within 45 minutes; insensible within 2 hours
1,600 ppm (0.16%)	Headache, tachycardia, dizziness, and nausea within 20 minutes; death in less than 2 hours
3,200 ppm (0.32%)	Headache, dizziness and nausea within 5-10 minutes; death within 30 minutes
6,400 ppm (0.64%)	Headache and dizziness in 1-2 minutes; convulsions, respiratory arrest, and death in less than 20 minutes
12,800 ppm (1.28%)	Unconsciousness after 2-3 breaths; death in less than three minutes

Warranty Statement for the Model OI-315

Hardware

Otis Instruments, Inc. warrants the OI-315 TOCSIN³ to be free of defects in workmanship and materials—under normal use and service—for one year from the date of purchase from the manufacturer or from the product's authorized reseller.*

The manufacturer is not liable (under this warranty) if its testing and examination disclose that the alleged defect in the product does not exist or was caused by the purchaser's (or any third party's) misuse, neglect, or improper installation, testing or calibrations. Any unauthorized attempt to repair or modify the product, or any other cause of damage beyond the range of the intended use, including damage by fire, lightening, water damage or other hazard, voids liability of the manufacturer.

In the event that a product should fail to perform up to manufacturer specifications during the applicable warranty period, please contact the product's authorized reseller—or visit the “Service” page at www.otisinstruments.com for repair/return information.

Any repaired or replaced product or part has either a 90-day warranty or the remainder of the initial warranty period (whichever is longer).

*The OI-315 battery is not covered under this warranty.



Otis Instruments, Inc.

301 S Texas Ave.
Bryan, TX 77803

Corporate Office: 979.776.7700

service@otisinstruments.com
www.otisinstruments.com